



Service • Support • Success

---

## Operating Manual

# Prep/Master<sup>®</sup> RC-3030 (Remote Control)



---

# Table of Contents

---

1.0	Technical Data . . . . .	1
2.0	Safety Instructions . . . . .	3
3.0	General Information . . . . .	8
4.0	Transportation. . . . .	14
5.0	Starting the Machine . . . . .	16
6.0	Operation of the Machine. . . . .	18
7.0	Maintenance . . . . .	24
8.0	Troubleshooting / Diagnostics . . . . .	26
9.0	STI Reference Guide & Procedures . . . . .	28

---

 ***Please note: The following safety instructions must be followed as shown in this operating manual. Failure to do so may result in hazard to health or possible death.***

---

### **Prep/Master® Warranty**

Substrate Technology guarantees that its machines and products are without manufacturing defects. The warranty period on machines is one (1) year from the date of sale and the variable speed drive carries a two (2) year warranty from the date of sale. Substrate Technology will replace any part that is defective at its own cost within the warranty period. This warranty does not cover wear items or instances of abuse or neglect.

\*\*\*When transporting P/M machines, it is ***mandatory*** to move all pocket weights to the head of the grinder, or off the machine. Failure to do so will result in damage to the handle frame that is not covered under warranty.

## 1.0 Technical Data

- 1.1 Rating
- 1.2 Unit Specifications
- 1.3 Operative Range and Correct Usage
- 1.4 Stand-by Power Supply (Generator)
- 1.5 Advice for Operators of Grinding Machines
- 1.6 Machine Type Designation

### 1.1 Rating

Machine: Prep/Master® Grinder  
 Machine-Type: RC-3030  
 Manufacturer: Substrate Technology  
 1384 Bungalow Rd.  
 Morris IL 60450 USA  
 +1.815.941.4800  
 www.substratetechnology.com

### 1.2 Unit Specifications

***RC-3030 Dimensions:***

Length	97 in	246 cm
Width	30 in	76 cm
Height	64 in	163 cm
Weight	1,850 lbs.	839 Kg

***Connected loads of the electrical system:***

Power	25 HP - 3 phase   18.6kW
Power Cord	[6-4]
Electrical Connection	220/230 VAC 3 Phase, 50-60Hz 380/480 VAC 3 Phase, 50-60Hz

### 1.3 Operative Range and Correct Usage



*The Prep/Master® RC-3030 is designed to be used on clean, dry or wet horizontal surfaces without obstacles. The machine cannot be used for other purposes. The manufacturer will not be liable for damages resulting from such incorrect usage. In case of wrong usage the user is responsible for all risks.*

## 1.4 Stand-by Power Supply (Generator)



*If the Prep/Master® RC-3030 is operated using a generator, the generator must be operated in accordance with the current local electrical directives (this applies in especially to the protective ground conductor) in order to ensure that all safety devices are functioning and to be able to eliminate possible damage to electrical components.*

## 1.5 Advice for Operators of Grinding Machines



*During the operation of the Prep/Master® RC-3030 it may be possible to exceed the acceptable noise level of 85 dB(A). This is dependent on the different locations and the local circumstances. When the noise level is 85 dB(A) or more, the machine operator and the persons working near the machine must wear sound-insulating devices.*

## 1.6 Machine Type Designation

Machine Type:	Prep/Master® RC-3030
Working Width:	30 in. (72 cm)
Drive:	Manual / Remote Control
Grinding Capacity:	Variable
Tools Needed	12
Tools RPM	250 RPM to 750 RPM variable
Tools Attachment Style	EG Proprietary Attachment System
Dust Hose Connection:	3 in. (76mm) x 25 ft. (8m)
Recommended Vacuum	Duo Vac (630CFM) with pre-separator or equivalent

---

## 2.0 Safety Instructions

---

- 2.1 Explanation of Warnings and Symbols
- 2.2 Organizational Measures
- 2.3 Personnel Selection and Qualification
- 2.4 Safety Precautions Applicable to Different Operating Conditions
- 2.5 Repair Work, Maintenance Activities, and Default Repair on the Job Site
- 2.6 Definition of the Safety-off Position
- 2.7 Dangerous Aspects of the Machine
- 2.8 Electrical Engineering Regulations
- 2.9 Special Instructions



***The following safety instructions must be followed as shown here. Failure to do so may result in hazard to health or possible death.***

---

---

### 2.1 Explanation of Warnings and Symbols

---

***The following symbols are used in the operating instructions to highlight areas of particular importance:***



#### **Operational Safety**

This symbol will be shown in these Operating Instructions next to all safety precautions that are to be taken in order to ensure prevention of injury. Follow these instructions and take special care in these circumstances. In addition to these instructions, the general safety precautions and the local accident prevention guidelines are also to be followed. Please check, whether there are special regulations for the particular job site.



#### **Safety Goggles/ Ear Protection**

Information, instructions, and restrictions with regards to possible risks to persons or extensive material damages.



#### **Electrical Warning**

Warning against dangerous voltages.

---

### 2.2 Organizational Measures

---



***The Operating Instructions are to be kept near the location where the machine is located and must be reachable all the time!***

---

In addition to the Operating Instructions, general and legal regulations regarding accident prevention and environmental protection must be with and indicated every time!

Such duties may for example relate to the handling of hazardous substances or to the provision and wearing of personal protection equipment as well as compliance with local traffic regulations.

The Operating Instructions must be supplemented by instructions including the duty to supervise and report relating to particular local working practices, for example work organization, work procedures, and personnel allocation.

Personnel entrusted with working with the machine must have read the Operating Instructions before starting the work; in particular the chapter about Safety Instructions. These have to be read before starting any work with the machine. This particularly applies to incidental activities such as setting up the machine, carrying out maintenance work, or training staff to work with the machine.

From time to time the working practices of the staff are to be checked regarding awareness of safety and hazards.

Personnel must tie back long hair and not wear loose clothing or jewelry and rings. There is a risk of injury through getting stuck or being drawn into moving machinery.



---

*Use personal protection equipment if necessary or required by regulations! Take notice of all safety and hazard notices on the machine.*

---

All safety and hazard notices on the machine must be kept complete and legible.

If safety-critical changes occur to the machine or its performance, the machine must be shut down immediately! The cause of the fault has to be established immediately and has to be repaired before starting the work again.



---

*Changes, add-ons, or conversions of the machine which might have an influence to the safety of the machine must not be undertaken without the permission of the manufacturer.*

---

This applies in particular to the fitting and adjustment of safety devices and to welding on major and load bearing parts.

Spare parts must always comply with the technical requirements and the specifications of the manufacturer. This is always guaranteed with original spare parts of the manufacturer.

Inspection intervals and intervals for recurring checks specified in these Operating Instructions must be complied with. At the same time it is necessary to meet the legal requirements.

To perform maintenance work correctly it is important to be equipped with proper tools for the task in question.

The location and the operation of fire extinguishers must be made known on each building site! Take note of the facilities for fire reporting and fighting fires!

---

## **2.3 Personnel Selection and Qualification**

---

Only reliable personnel are allowed to work on the machine or operate the machine. Note the statutory minimum age. Specify clearly the responsibilities of personnel for operation, setting up, servicing and maintenance work. Define his/her responsibilities also with regard to traffic safety regulations and empower him/her to decline instructions from third parties which are not complying with the safety requirements.

Personnel being trained or made acquainted with the equipment may only be deployed under constant supervision of an experienced person.



*Work on the electrical parts of the equipment may only be undertaken by a skilled electrician or by a trained person under the guidance and supervision of a skilled electrician as well as in accordance with the electrical engineering regulations.*

## 2.4 Safety Precautions Applicable to Different Operating Conditions

Avoid any method of working that impairs safety! All precautions have to be taken, that the machine will only be used in a safe and functional status.



*Only operate the machine when all safety devices and related safety equipment, e.g. detachable safety devices, emergency stops, and suction devices are present and operational!*

The machine has to be checked visually at least once a day for any damage and defects. In the event of operational malfunctions the machine must be shut down immediately and secured. The fault must be rectified before starting the machine again!



*Secure the work area around the machine in public areas providing a safety distance of at least 10 feet around the machine.*

### **Fault must be rectified immediately!**

Start up and switch off operations and control devices have to be handled in accordance with the Operating Instructions.



*All persons in the proximity of the machine must wear safety glasses with lateral protection as well as safety shoes. Ear protection may be required. The operator is obliged to wear close fitting protective clothing.*

Use only extension cables for extending the main cable that are sized and marked in accordance with the overall power consumption of the machine and the valid local guidelines.. Before starting the machine make sure that nobody can be endangered when the machines starts running.



*Do not switch off or remove the exhaust and ventilation devices when the machine is running!*

## 2.5 Repair Work, Maintenance Activities, and Default Repair on the Job Site



*Before starting any servicing work on the machine, put the machine in the Safety off position as described in chapter 2.5 in order to prevent the machine from being switched on accidentally.*

Please follow any special safety instructions in the various chapters on servicing the machine. (See chapter 7.)

Adjustments, servicing, and inspection work and inspection intervals specified in these Operating Instructions as well as any information on the replacement on parts and systems of the machine must be undertaken and / or complied with.

These activities can only be undertaken by qualified personnel. Before starting any maintenance or repair work the operator of the machine has to be informed about it.

During all work related to the use, the re-erection or the adjustment of the machine and of the safety devices as well as inspection, maintenance and repair, the start up and shut off procedures have to be done in accordance with the Operating Instructions.

For the machine to be shut off completely for repair or maintenance work the plug has to be disconnected in order to prevent the machine from being switched on accidentally.

The dust bin of a connected dust collector has to be emptied before transportation. Please handle in accordance with the regulation how to dispose the dust and make sure that you meet the local regulations.

Do not use any aggressive cleaning materials! Use lint-free cleaning cloths.

Always tighten any screw connection that is undone during servicing and maintenance work.

If safety devices need to be dismantled during setting up, servicing and repair work, these safety devices must be reinstalled and inspected immediately after completion of the servicing and repair work.

Make sure that process materials and replacement parts are disposed of safely and in an environmentally-friendly manner!



*Work on the electrical parts of the equipment may only be undertaken by a skilled electrician or by a trained person under the guidance and supervision of a skilled electrician as well as in accordance with the electrical engineering regulations.*

Make sure that electrical components used for replacement purpose comply with the original parts and are correctly adjusted if necessary.

---

## 2.6 Definition of the Safety-off Position

---

### **Definition:**

The safety off position is the position of the machine when it cannot generate any hazard.

### **Putting the machine in the safety-off position means:**

- Switch off the grinder.
- Switch off the dust collector.
- Wait for standstill of all drives.
- Pull out main plugs.
- Secure the machine against unintended start up.



## 2.7 Dangerous Aspects of the Machine



*Every machine, if it is not used according to the regulations, may be hazardous for operating, setting-up and service personnel. The operating authority is responsible for compliance with the safety regulations during operation and maintenance of safety devices supplied with the machine as well as the provision of appropriate additional safety devices.*

## 2.8 Electrical Engineering Regulations



*Never start machine in the tilted position. The machine must only be started when all guards and dust collection parts are attached and machine is standing flat on work surface.*



*Work on the electrical parts of the equipment may only be undertaken by a skilled electrician or by a trained person under the guidance and supervision of a skilled electrician as well as in accordance with the electrical engineering regulations.*



*Use only extension cables for extending the main cable that are sized and marked in accordance with the overall power consumption of the machine and the valid VDE guidelines. In case there is any question ask the manufacturer or a skilled electrician.*

If work on electrified parts is necessary, a second person must be deployed who can pull out the plug in an emergency. The working area must be sealed with a red and white safety chain and a danger sign. Use tools that are insulated against voltages.

Only start work, once you are familiar with the electrical engineering regulations that apply to your area. Only use voltage testers that comply with the regulations when troubleshooting. From time to time check voltage tester to ensure that they are operationally efficient.

## 2.9 Special Instructions

Use only proper and default free tools for your work. Damaged tools have to be repaired immediately or to be replaced.

Use during your work for your own safety the required safety equipment and safety clothes (e.g. safety glasses, safety shoes, safety gloves).

### ***Please instruct operators and repair personnel about the following points:***

- Cleaning and repair work are only allowed if the machine is shut off (safety off position).
- During work on the machine, be certain that the machine cannot be started.
- Opening or removing safety devices while the machine is running are not allowed.
- Replace all safety covers and devices after cleaning, repair, and maintenance work.
- Do not touch moving parts and do not walk into the working path of the machine.
- Before restarting machine, make sure all personnel are a safe distance away from the work area after initial start up.

---

## 3.0 General Information

---

- 3.1 Operative Range
- 3.2 Scope of Supply
- 3.3 Operating Features
- 3.4 Exploded Diagrams & Part Numbers of Gear Box
- 3.5 Wear Parts & Part Numbers
- 3.6 Handle Settings
- 3.7 Electric Motor
- 3.8 Robotic Wheels
- 3.9 Cutting Area
- 3.10 Couplers & Tools Plates
- 3.11 Tool Change
- 3.12 Care & Maintenance

---

### 3.1 Operative Range

---

The STI Prep/Master® RC-3030 is a grinding machine with counter rotating heads that is used for preparation and polishing of horizontal surfaces. Grinding the surface according to STI specifications thoroughly removes surface contaminants, coats of paint, sealants, and thin coatings.

A suitable filter unit must be connected to the machine in order to thoroughly collect the dust being produced by the grinding process. The proper dust collection system ensures dust-free operation of the machine and clean air at the workspace.

---

### 3.2 Scope of Supply

---

***Provided with machine:***

- Prep/Master® RC-3030
- Remote Controller
- Two (2) Rechargeable Batteries
- Transportation Leg
- Manual (1)

---

### 3.3 Operating Features

---

***Remote Controller***

The Remote Controller is a radio-operated device that allows the machine to be remotely controlled by an operator. A waist strap holds the device securely around operator's waist to reduce handling fatigue.

The controller is supplied with two rechargeable batteries for continued operation. Use the battery charger located under the seat to keep battery charged when not in use.



### ***Built-in Battery Charging System for Remote Controller***

The battery charging system is located just under the machine's seat inside the electronics case.

To find access the charging system, unfasten the U-clips located at the back of the electrical case to allow access to the system. Lift handle on left side of seat to disengage and pull seat forward. Then, lift up lid of electrical case. The charging system is located on the right side of the case's inside wall.



### ***Emergency Stop Button***

Emergency Stop Switch is intended to be used for the safety of the operator and protection of the machine from excessive damage in the event of an emergency.

There are three Emergency Stop buttons located on the machine: 1) on the back of machine, 2) on the handle control panel, and 3) on the remote controller.

#### **How to Use the Emergency Stop Button**

1. To quickly stop the machine in cases of emergency, depress the Emergency Stop Button.
2. Reset it by turning button 45 degrees clockwise until knob pops out.

### ***Swing Weight System***

The Swing Weight System is used to easily transfer extra weight to the head of the machine (over the gear box) for grinding head pressure and for transportation; or to the back of the machine for tipping the machine back for easy tool change. The neutral position (located in the center of the machine) is designed for lighter grinding head pressure.

To unlock the weights from their position, pull on the knob located at the end of the arm.

### ***Phone Charger Port***

The machine is equipped with a DC 12-Volt power outlet for phone charging. It is located on the front of the electrical case just under the machine seat.

### ***"S-Curve" Motion Grinding Pattern***

The "S-Curve" motion is a specific pattern of grinding used to level the floor more evenly. For optimum grinding and polishing, it is always best to use the "S-Curve" motion for automatic and for manual operation. The remote controller "Auto-Leveling" feature has the "S-Curve" motion built in.

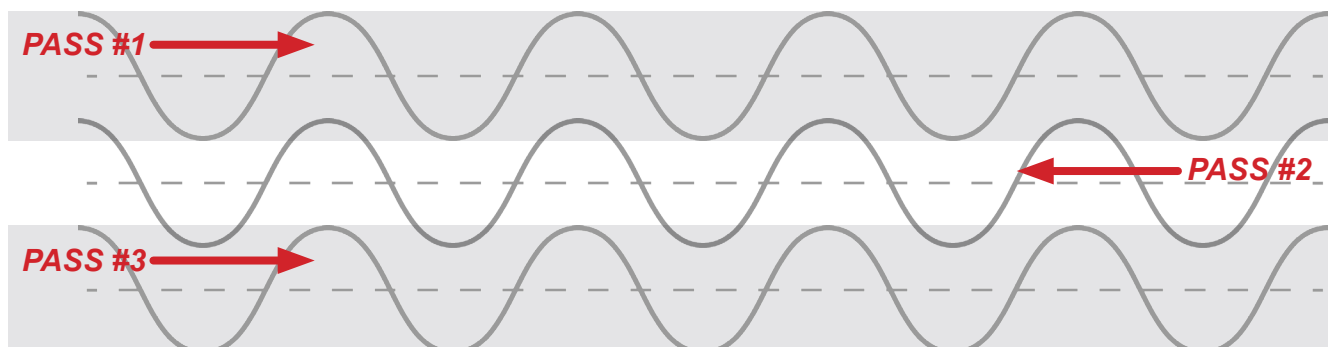

*Follow this grinding pattern for optimum leveling – Overlap each path by about 20%.*

### 3.4 Exploded Diagrams & Part Numbers of Gear Box

Item #	Qty	Part #	Description
3	8	322090000	Bearing w/Race
4	8	473372200	Oil Seal
5	4	880001172	Helical Gear Key (SM-072)
6	4	881102012	Woodruff Key 3/8 x 1 1/4
7	**	881121405	Shim .005
8	**	881121407	Shim .007
9	**	881121420	Shim .020
13	4	40193	Locknut M24
14	6	1139623	Soc HD M10 x 50 Grade 12.9
15	24	1138657	HHSC M10 x 35
17	16	1138656	HX M10 x 30
18	4	47577	Stud M18 x 2.5 x 3" LG
19	4	40183	Lock Nut M18
20	1	66374	Sq. HD Plug 3/4-14 NPT
21	1	66375	Sq. HD Plug 1" NPT
23	1	HR0240	Helical Gear
24	1	HR0242	Housing
25	1	HR0244	Cover
26	1	630309512	Input Pinion
27	4	HR0554	Bearing Cover
28	2	HR0248	Helical Gear 89T RH
29	2	HR0249	Helical Gear 89T LH
30	4	HR0250	Shaft
31	4	884000893	Coupling Flange
33	1	560250240	Motor 25HP 3 Phase
34	16	18918	1/2"-20 3" Capscrew
35	16	33895	1/2" Lockwasher
36	4	880000602	602 Morflex Coupler
37	4	885013030	Aluminum Tool Plate
38	12	570000014	EG Female Adapter QC

\*\* Quantity varies

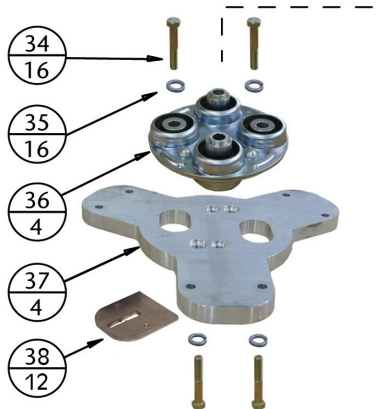
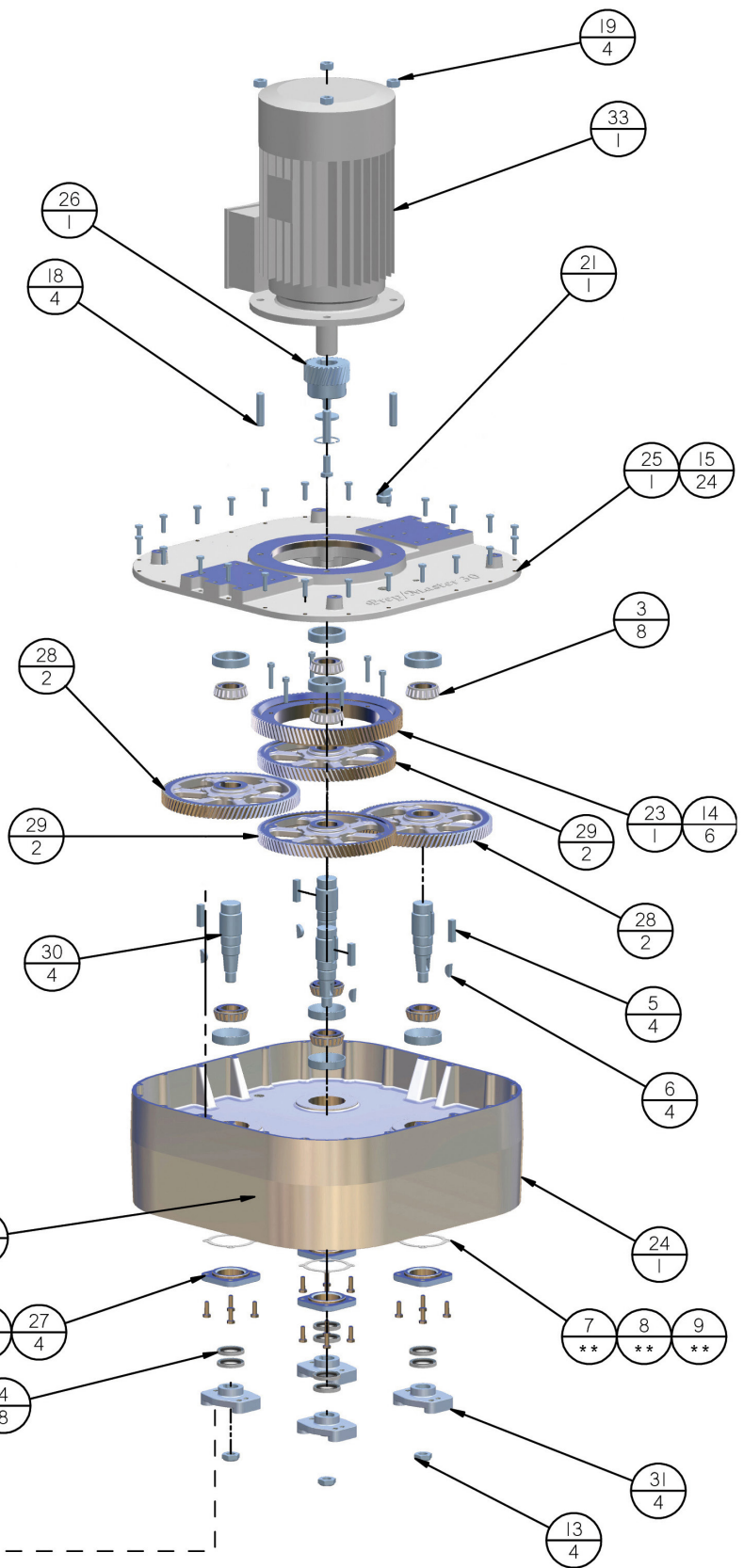

### 3.5 Wear Parts & Part Numbers

Item #	Qty	Part #	Description
1	2	618092301	Handle Grips (right & left)
2	2	618092302	Gas Spring Set
3	8	618092303	Knobs
4	2	618092304	LED lights
5	2	618092305	Wheels
6	2	618092306	Rechargeable Batteries

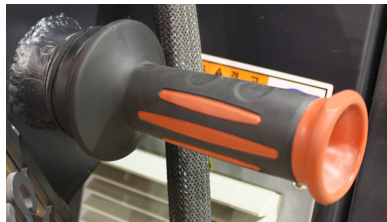

1) Handle Grip



3) Knob

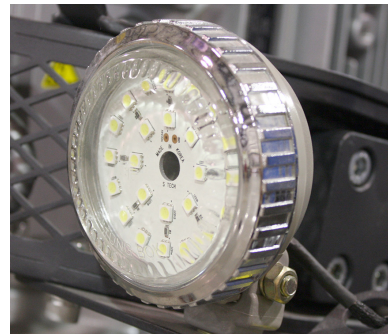

4) LED Light



2) Gas Spring (located on swing weight level arms)



5) Wheel



6) Rechargeable Batteries

### 3.6 Handle Settings

The handle height is set with the help of two spring-loaded knobs on each side of the handle joint. To move the handle up or down:

1. Pull out the knobs on both sides of the handle joint by twisting clockwise or counter-clockwise 45 degrees to place knob in a disengaged position.
2. Move the handle to the desired position, and then twist knob clockwise or counter-clockwise to reengage locking feature.



**Upper Position:** for tipping machine back & tool change

#### Handle's Varied Positions

1. **Upper Position:** 1) for tipping machine back; and 2) to make tool change
2. **Middle Position:** 1) for manual control of machine
3. **Lower Position:** 1) for remote control; and 2) transportation of machine



**Middle Position:**  
for manual operation



**Lower Position:** for remote operation and transportation

### 3.7 Electric Motor

The power plant of the P/M grinder is the electric motor. The motor is responsible for turning the gears which turn the abrasive tools on the floor. The motor is controlled exclusively by controls on the back, handle, and remote controller which inputs specific power to generate a given RPM.

### 3.8 Robotic Wheels

The Robotic wheels are controlled by two smaller drive motors for remote control operation. The two knobs control the state of the wheels. Set the wheels into a "locked" state for remote control operation, or "unlocked" state for manual control operation.



### 3.9 Cutting Area

The area inside the stainless steel shroud and directly beneath the gear deck is the cutting area. This is the area in which the tools turn to produce the grinding action. It is also the area that keeps the dust from grinding contained and subsequently evacuated through the dust collection ports.

### 3.10 Couplers & Tool Plates

The grinder is outfitted with couplers and tool plates. The couplers attach to the tool plates and provide flex for smooth operation of the diamond tools. The tool plate holds the tools in place for the grinding application.

### 3.11 Tool Change

1. In order to change the tools, the operator must first ensure that the grinder is switched off and the power plug is disconnected from electrical source.
2. Place both right-side & left-side swing weights into the "back" position.
3. Set the handle into the upper "tool change" position by pulling & twisting knobs on both sides of the handle joint.
4. Push machine down by handle in a controlled manner until grinder is resting on the floor.
5. Inside the gear box, tap the tools from the outside edge of the tool to remove from tool plate.
6. Remove all debris from tools and tool plate. Tools must lay flat against tool plate in order to work properly.
7. Install new tools by sliding the tooling outward to fit into slot securely.



*Machine must only be tilted back on firm, level surface. There is danger of machine falling if weights are not used and surface is not level.*

### 3.12 Care & Maintenance

Special attendance and regular maintenance of the machine and its parts are imperative for functioning and safety. In order to prevent unnecessary downtimes it is recommended to keep original spare and wear parts on stock.

***The following maintenance should take place before & after every operation of machine:***

1. Clean all surfaces with a dry, lint free cloth
2. Inspect all electrical cables for cuts and replace damaged chords
3. Check all electrical connections are secure and snug
4. Inspect gear box for any signs of oil leakage and repair as required
5. Verify functionality of all three (3) Emergency Stop buttons.

---

## 4.0 Transportation

---

- 4.1 General Notes
- 4.2 Transportation
- 4.3 Hoisting
- 4.4 Transportation by Vehicle
- 4.5 Operation Conditions

---

### 4.1 General Notes

---

Before the machine used for the first time, STI authorized dealers offer a course to familiarize maintenance and operating personnel with all elements of the machine. We are not liable for damage caused by incorrect use of the machine by personnel.

---

### 4.2 Transportation

---

To easily transport the machine, use the Transportation Leg provided with the machine.

1. To attach the leg, set handle in the upper position and place the machine in its tipped back position.
2. Remove lower bolt of the leg bracket and slide the hook of the leg onto the top bolt of the machine.
3. Insert and tighten the lower bolt.
4. Tip the machine forward into an upright position. Use the leg & wheels to transport machine safely.



**IMPORTANT:** When transporting P/M machines by vehicle or trailer, it is **mandatory** to move all swing arm weights to the head of grinder. Failure to do so may result in damage to the machine & handle frame that are not covered under warranty.

---



---

### 4.3 Hoisting

---

When transporting the machine with hoisting equipment like a crane or a lift, check the total weight permitted (see Chapter 1 - dimensions). Please use only appropriate, allowed, and qualified hoisting equipment as well as ropes and chains.

Do not fix any rope or chain to any part of the machine. The machine must be placed on a pallet or platform designed to hold the weight of the machine and the platform or pallet can then be lifted or hoisted from the appropriate points.



---

#### **4.4 Transportation by Vehicle**

---

When transporting the machine with a vehicle, proceed in such a manner that damage due to the effects of use of force or incorrect loading and unloading is avoided. Use straps to tighten the machine to the cabin of the vehicle.

Use at least two straps, or tighten the machine with one strap to the cabin wall of the vehicle. Make sure, that all parts of the machine are fixed.

---

#### **4.5 Operation Conditions**

---

Check the surface to be treated for loose parts (stones, screws, etc.). The surface must be swept if necessary. Make sure that the machine can travel over all inequalities on the surface. Small inequalities like floor joints less than  $\frac{1}{4}$  inch are no barriers for the machine.

The machine must be operated in accordance with instructions given in Chapter 5—Initial operation.

---

## 5.0 Starting the Machine

---

### 5.1 Preparing for Initial Operation

#### 5.2 Initial Operation

---

### 5.1 Preparing for Initial Operation

---

Before start up ensure all existing protective housings are fitted and the filter unit is connected correctly.



*All persons in the proximity of the machine must wear safety glasses with lateral protection as well as safety shoes. The operator is required to wear close-fitting protective clothing.*

---

Carefully handle all plugs, cables, hoses, and operating devices. Avoid any contact with live wires.

Work on the electrical system has to be done only by qualified specialists.

Check the surface to be treated; it should be free of for loose parts (stones, screws, etc.). The surface needs sweeping if necessary. Ensure that the machine can run over all inequalities on the surface. Small inequalities like floor joints aren't a barrier for the machine.

***In order to avoid downtimes a regular inspection is essential. Carry out the following checks before any start-up:***

- Check whether all machine parts are assembled safely and correctly.
- Check all screws and other fasteners for tight seat.
- Check the tool holders to ensure that the proper tools are in place and secure.
- Check the tightness of the hose connections and the condition of the hose to the filter.
- Make sure the dust container of the filter unit is empty. Please comply with the local waste treatment regulations considering the removed material.
- Check the electrical connections for dirt and foreign body deposits.
- Check the electrical motors for dirt and other contaminants.



*Before start-up operators and other personnel must be familiar with the safety regulations given in this manual.*

---

1. Place the grinder in the area where work is to begin.
2. Place swing weights on grinding head.
3. Check the main power cable and the dust hose for damage. Replace or repair all damaged parts before starting the machine.
4. Connect the grinder and the filter unit with the dust hose.
5. Connect the supply cable of the P/M machine\* with the site supply. Make sure that the correct electric supply is available.



*\*An authorized electrician must verify proper voltage before turning on the machine!  
Damage to VSD will occur if voltage is incorrect.*

## 5.2 Initial Operation



*All persons near the machine must wear safety glasses with lateral protection, ear protection as well as safety shoes. The operator is obliged to wear close fitted protective clothing.*

Before start-up the operating personnel must be familiar with the safety regulations given in this manual.



*Attention! Before you plug the equipment to a power supply make sure the power supply is equivalent to the data shown on the machine label.*

### **Initial operation of the grinding machine:**

1. Attach the appropriate tools on the tool plates.
2. Connect the machine power plug to the required power source.
3. Assure the dust hose is connected correctly to filter and machine.
4. Switch on the filter unit.
5. Check that the main switch is turned on.
6. Turn the Main Power switch to "On."

The machine can be operated manually through the handle's control panel, or automatically through the remote controller. Refer to Chapter 6 "Operation of Machine" for preferred mode of operation.

7. After start-up, immediately begin moving the machine in the "S-Curve" pattern (see page 9 – Chapter 3.3 for explanation) to prevent the tools from digging into the concrete surface and creating an uneven profile. For the operation of the running machine, it is necessary to move the machine in the "S-Curve" to create an even cut that is consistent in flatness and profile. Only push machine in a straight line when grinding or polishing an edge.
8. When grinding in work area is complete, follow the instructions for stopping the machine.
9. The dustbin of the filter unit needs regular dumping.



*Do not overfill the bin to avoid dust exposure when opening the bin. Comply with the local waste treatment regulations considering the removed material.*

---

## 6.0 Operation of the Machine

---

- 6.1 Daily Operation
- 6.2 Failure
- 6.3 Restart
- 6.4 Control Panel Overview (Machine Back)
- 6.5 Handle Control Panel Overview (Manual Control)
- 6.6 Simple Procedure for Engaging Manual Control
- 6.7 Operation of Machine Using the Handle Control Panel (Manual Control)
- 6.8 Control Panel Overview (Remote Control)
- 6.9 Simple Procedure for Engaging Remote Control
- 6.10 Operation of Machine Using the Remote Control

---

### 6.1 Daily Operation

---

Preparing for start-up and initial operation of the grinder is described in Chapter 5 "Starting Machine."

Perform grinding operation in parallel tracks in a way that the dust hose and electric cable do not become twisted.

Make sure that no vehicles, such as forklift trucks and other equipment, run over the electric cable and the dust hose. The speed of moving the grinding machine over the work surface will influence the final finish and production.

In the case that the surface shows different characteristics, specifically different hardness or coating thicknesses, a uniform grinding result will be achieved by varying the speed of movement over the surface.

---

### 6.2 Failure

---

Regardless of the following information, the local safety regulations must be followed in any case of operation of the machine. Assure all turning machine parts have come to standstill before inspection or maintenance work starts. Always use the Safety Off as described in Chapter 2.

---

### 6.3 Restart

---



*All persons in the proximity of the machine must wear safety glasses with lateral protection as well as steel toes work boots and hearing protection. The operator is also required to wear close-fitting protective clothing. See Chapter 5—Initial Operation.*

---



### 6.4 Control Panel Overview (Machine Back)

No.	Item	Description
1	Power Lamp	Green light is on when the start key (#7) is turned to the right (ON)
2	Inverter-Trouble	Red light is on when the inverter has an overload to indicate problem has occurred. Press the Trouble Reset (#10) button.
3	Working Time Display	Counts how many hours the machine has been at work
4	Radio Lamp	Red light is on when operating via Remote Control
5	Manual Lamp	Green light is on when operating via Manual Control
6	EM-STOP Lamp	Red light is on when Emergency Stop (#12) is engaged
7	Power (On/Off)	Insert and turn the Start key to the right (ON). Turn the start key to the left (OFF).
8	LH-SPEED	Control knob to adjust left wheel speed
9	RH-SPEED	Control knob to adjust right wheel speed
10	Trouble Reset	Resets the Inverter (lifts the power overload). When engaged, the Inverter-Trouble lamp (#2) will turn off.
11	Mode (Radio / Stop / Manual)	Switch to "Radio" to pair with Remote Controller / Switch to "Stop" to stop gears / Switch to "Manual" to use Control Panel settings on handle
12	EM-STOP	Emergency Stop Button. Press down to engage. Turn knob clockwise 45 degrees until it pops up to disengage.



## 6.5 Handle Control Panel Overview (Manual Control)

No.	Item	Description
13	EM-STOP	Emergency Stop Button. Press down to engage. Turn knob clockwise 45 degrees until it pops up to disengage.
14	Start	Press button to start the machine. Green light becomes lit.
15	Grinder Selection (FWD / Reset / REV)	Switches grinding heads for rotation clockwise (FWD), counter clockwise (REV), or Reset
16	Light	Switch LED headlights ON/OFF
17	Stop	Press button to stop the machine. Red light becomes lit.
18	Grinder-Speed	Controls the grinding head's rotation speed

## 6.6 Simple Procedure for Engaging Manual Control

1. Secure wheels in "unlocked" state (pull and twist all four wheel knobs into OUT position).
2. Turn **Power** (#7) to ON. Power Lamp (#1) becomes lit.
3. Turn **Mode** (#11) to "Manual." Manual Lamp (#5) becomes lit.
4. Use **Grinder Selection** (#15) to rotate grinding heads in desired direction (FWD or REV).
5. Press the **Start** button (#14) to start machine. Green light lights up.

## 6.7 Operation of Machine Using the Handle Control Panel (Manual Control)

1. Connect the machine power plug to the required power source.
2. Turn on the vacuum, if it is to be used.
3. Locate the two wheel knobs on both wheels. Pull knobs out and twist clockwise 45 degrees to put into their "unlocked" position. Wheels should now move freely for manual control.
4. Set the handle into the middle "working" position.
5. ON the back of the machine, turn the Power Key (#7) to the right "ON."
6. Make sure the "Emergency Stop" buttons (#12 & #13) are in their upper positions. If not, reset by turning them 45 degrees clockwise, until they pop out again. **(NOTE: if the emergency stop button is pressed, the machine cannot be started.)**
7. Press the "Trouble Reset" button (#10) once to reset.
8. Select desired rotation direction of the grinding heads on the Grinder Selection switch (#15).
9. Press the Start button (#14) to activate the machine.
10. Adjust grinder wheel speed with the LH-SPEED & RH-SPEED control knobs (#8 & #9).
11. On the handle panel, turn the Grinder-Speed knob (#18) to adjust the grinding speed from 0% to 100%.
12. Start to move machine in the "S-Curve" motion to begin the grinding process (see page 9 – Chapter 3.3 for explanation).



### Stopping the Machine using Manual Control

1. Turn the Grinder-Speed knob (#18) to the speed of 0%.
2. Set the Grinder Selection (#15) to "RESET" position.
3. Press the Stop button (#17).

### Performing an Emergency Stop

1. To stop machine quickly in cases of emergency, depress the Emergency Stop Button.
2. Reset it by turning button 45 degrees clockwise until knob pops out.

### Changing the Rotating Direction of the Grinding Heads

1. Set the Grinder-Selection switch (#15) to FWD or REV to select grinding direction: FWD for clockwise direction and REV for counter-clockwise direction.
2. To stop the machine, put switch at RESET position.



## 6.8 Control Panel Overview (Remote Control)

No.	Item	Description
19	EM-STOP	Emergency Stop Button. Press down to engage. Turn knob clockwise 45 degrees until it pops up to disengage.
20	Engine (START/STOP)	Flip up to link remote controller to machine. / Flip down to unlink.
21	Grinder (FWD/STOP)	Flip up to start rotation of grinding heads (clockwise only). This starts the main motor. / Flip down to stop main motor.
22	Auto-Leveling (ON/OFF)	Flip up to engage Auto-Leveling function. This begins the "S-Curve" motion of the machine. / Flip down to disengage.
23	0 / I-Start	Turn switch to the right and hold for 3 seconds to connect the machine to the Remote Controller. The inverter is activated with sound. / Turn switch to the left to disengage.
24	Radio Enabled Lamp	Remote Controller's Signal Indicator
25	Steering (L/R)	Control lever for moving the machine left (L) or right (R)
26	Steering (F/R)	Control lever for moving the machine forward (F) or reverse (R)

## 6.9 Simple Procedure for Engaging Remote Control

1. Secure wheels in "locked" state (twist all four wheel knobs into IN position).

### **On the Control Panel (Machine Back):**

2. Turn **Power** (#7) to ON. Power Lamp (#1) becomes lit.
3. Turn **Mode** (#11) to "Radio." Radio Lamp (#4) becomes lit.

### **On the Remote Controller:**

1. Turn **0 / I-Start** (#23) to the right for 3 seconds. Radio Enabled Lamp (#24) becomes lit.
2. Flip **Engine** switch (#20) to START to link Remote Controller to the machine.
3. Flip **Grinder** switch (#21) to FWD to start the main motor.
4. Flip **Auto-Leveling** switch (#22) to ON to start the "S-Curve" motion (*see pg. 9 for explanation*)
- 22 5. Use **Steering** levers (#25 & #26) to move machine in desired direction.



## 6.10 Operation of Machine Using the Remote Control

1. Connect the machine power plug to the required power source.
2. Turn on the vacuum, if it is to be used.
3. Locate the two wheel knobs on both wheels. Twist knobs counter-clockwise 45 degrees to set into their "locked" positions. Wheels can now be used for remote control operation.
4. On back of the machine, turn the Power Key (#7) to the right "ON."
5. Turn Mode (#11) to "Radio." Radio Lamp (#4) becomes lit.
6. Make sure the Emergency Stop buttons (#12 & #19) are in their upper positions. If not, reset by turning them 45 degrees clockwise, until they pop out again (**NOTE: if the emergency stop button is pressed, the machine cannot be started.**)
7. Set the handle into the Lower "remote control" position.
8. On remote controller, turn switch 0 / I-Start (#23) to the right and hold for 3 seconds to engage. Radio Enabled Lamp (#24) becomes lit.
9. Flip Engine switch (#20) to START to start engine.
10. Flip Grinder switch (#21) to FWD to start rotation of the grinding heads.
11. Flip Auto-Leveler switch (#22) to ON to begin "S-curve" motion of the machine. The "S-curve" is a specific movement of the machine that helps to level the floor profile (see page 9 – Chapter 3.3 for explanation). Turn to "OFF" to run the machine in a straight line for edge work.
12. To control direction of the machine, use Steering control levers (#25 & #26).
13. If necessary, on back of machine, adjust grinder wheel speed using the LH-SPEED & RH-SPEED control knobs (#8 & #9).
14. On the handle panel, turn the Grinder-Speed knob (#18) to adjust the grinding speed from 0% to 100% for desired speed.



### Stopping the Machine with Remote Controller

1. Set the Steering levers (#25 & #26) to the middle positions.
2. Turn the Grinder-Speed knob (#18) to the speed of 0% (if necessary).
3. Flip switch Auto-Leveler (#22) to OFF to stop "S-Curve" motion.
4. Flip switch Grinder (#21) to STOP to stop the grinding heads.
5. Flip switch Engine (#20) to STOP to stop the machine.

### Performing an Emergency Stop

1. To stop machine quickly in cases of emergency, depress the Emergency Stop Button.
2. Reset it by turning button 45 degrees clockwise until knob pops out.

### Changing the Rotating Direction of the Grinding Heads

1. Set the Grinder-Selection switch (#15) to FWD or REV to select grinding direction: FWD for clockwise direction and REV for counter-clockwise direction.
2. To stop the machine, set switch at RESET position.

## 7.0 Maintenance

- 7.1 Recommendations
- 7.2 Maintenance and Inspection
- 7.3 Maintenance
- 7.4 Regular Wear Parts
- 7.5 Service Schedule

### 7.1 Recommendations



*Prior to any repair work on the machine and its drives, secure machine against unintentional switch-on. Put the machine in Safety Off Position as described in chapter 2.*

Failures due to inadequate or incorrect maintenance may generate very high repair costs and long stoppage periods of the machine. Regular maintenance is essential. Safety and service life of the machine depend on proper maintenance.

The following table will show recommendations about time, inspection and maintenance for the normal use of the machine. The time indications are based on uninterrupted operation. When the indicated number of working hours is not achieved during the corresponding period, the period can be extended. Due to different working conditions it cannot be foreseen how frequently inspections for wear checks, inspection, maintenance, and repair works ought to be carried out. Prepare a suitable inspection schedule considering your own working conditions.

### 7.2 Maintenance and Inspection

Operating Hours/ Time Period	Inspection Points / Maintenance Instructions
Daily — Prior to Operation	<ul style="list-style-type: none"> <li>• Check all electrical cables for cuts or damage.</li> <li>• Check the hose connections for tightness and fixed seat.</li> <li>• Check the hose to the filter for damage.</li> <li>• Make sure that the dustbin of the filter has been dumped.</li> <li>• Check Morflex Coupler, tool plate, and diamond tooling for wear/damage.</li> <li>• Check that shroud and rubber seal are in good working condition.</li> <li>• Check the electric connections for sediments of dirt or foreign bodies.</li> <li>• Check the electric motor for dirt and other contaminants.</li> <li>• Check gear box assembly for any leaks of oil from motor and top and bottom of gear box.</li> </ul>
Daily — After Operation	<ul style="list-style-type: none"> <li>• Check for debris in the dust ports under gear box as well as at handle.</li> <li>• Check for dirt build up on variable speed drive and electric motor.</li> </ul>

### 7.3 Maintenance

Only those repair works are described which occur within the context of maintenance or which are required to replace wear parts. If you replace parts yourself for specific reasons, the following instructions and work sequence have to be observed. You should also stock all spare or wear parts that cannot be supplied quickly. As a rule, production standstill periods are more expensive than the cost for the corresponding spare part. Screws that have been removed must be replaced with those of the same quality (strength, material) and design.



*Prior to any repair work on the machine and its drives, secure machine against unintentional start-up. Pull out the main plug. Store plug near the machine to avoid accidents.*

### 7.4 Regular Wear Parts

Regular wear parts for the gear box is the Morflex Coupler.

**To replace a worn or damaged Morflex Coupler, perform the following:**

1. Remove ½ in.-20 bolts from drive plate using a ½ in. impact wrench and ¾ in. socket.
2. Use pry tool to remove assembly from drive plate.
3. Remove ½ in.-20 bolts from tool plate using a ½ in. impact wrench and ¾ in. socket.
4. Use pry tool to remove coupler from tool plate.
5. Replace with new coupler.
6. Replace bolts through new coupler and into tool plate\* tighten with impact wrench.
7. Place tool plate assembly onto drive plate with bolts\* tighten with impact wrench.

\* When replacing bolts, be sure to hand start bolts BEFORE using impact wrench to tighten down. This minimizes the risk of stripping the threads by tightening an unseated bolt.

### 7.5 Service Schedule

OPERATION	INTERVAL							
	Daily	First 8 Hrs.	Every 50 Hrs.	Every 100 Hrs.	Every 200 Hrs.	Every 300 Hrs.	Every 400 Hrs.	Every 500 Hrs.
Check oil level in gear box (optimal oil depth: 1¾ inch; use Mobilgear Oil 600 XP 150)				•				

## 8.0 Troubleshooting / Diagnostics

### 8.1 Diagnosis of Failures

### 8.2 Diagnosis of Electrical Failure

### 8.1 Diagnosis of Failures



*Prior to any repair work on the machine and its drives, secure the machine against unintentional start-up. Pull out the main plug in order to do this. Store the plug near the machine to avoid accidents.*

Failure	Possible Reasons for Failure	Corrective Actions
Unusual Vibrations	Uneven or loose surface being ground	Verify suitability of substrate being ground.
	Loose or damaged tooling	Inspect tooling to make sure that all connecting hardware is tight and tool is firmly seated to holder.
	Damaged or worn coupler	Replace coupler
Oil leak under gear box	Bad oil seal	Replace oil seal
Unusual Noise	Uneven or loose surface being ground	Verify suitability of substrate being ground.
	Loose or damaged tooling	Inspect tooling to make sure that all connecting hardware is tight and tool is firmly seated to holder.
	Shroud is dragging on the floor	Adjust shroud and tighten to no more than ¼ inch above floor
Reduced performance or no performance	Diamond tooling is worn or damaged	Inspect diamond tooling for remaining abrasive. If depleted, replace with new tooling.
Dust being produced	Shroud is out of adjustment	Adjust shroud and tighten to no more than 2 mm above floor.
	Dust hose is clogged	Inspect dust hose and ports for debris that may be clogging hose.
	Dust collector malfunction	Verify dust collector is operating properly

## 8.2 Diagnosis of Electrical Failure



*Prior to any repair work on the machine or drives, the machine must be secured against unintentional start-up. Put the machine in its Safety-off position.*



*Work on electrical equipment may only be undertaken by a skilled electrician or by trained persons under the guidance and supervision of a skilled electrician in accordance with the electrical engineering regulations.*

Failure	Possible Reasons for Failure	Corrective Actions
Motor does not start up	Missing Phase	Check power supply
	Faulty switch or relays	Get diagnosis and replacement by a skilled electrician
	Emergency Stop	Unlock the emergency stop button
Motor stops during operation	Current power is too high.	Disconnect plug.
	Supply circuit breaker is disengaged.	Reset circuit breaker or replace fuse.
	Motor is damaged.	Inspect motor.

## 9.0 STI Reference Guide & Procedures

- 9.1 Concrete Prep Diamond Tooling
- 9.2 Polished Concrete - EGT Polishing System (Dry Steps)
- 9.3 Polished Concrete - CLC Polishing System (Dry-Wet-Dry Steps)
- 9.4 Terrazzo Polishing - TPS Polishing System (Dry-Wet Steps)

### 9.1 Concrete Prep Diamond Tooling

Substrate Technology offers diamond tooling for any phase of the grinding or polishing process. Below is a list of those tools and their applications. Please refer to STI's TDS (Technical Data Sheet) for details of each procedure at [www.substratetechnology.com](http://www.substratetechnology.com).

#### **1) #0 Prep Tool (leaves a smooth profile)**

##### **Description**



The #0 Prep Tool is a metal bond preparation tool that has the EG attachment system as a standard for use on any P/M Machines. Its uses are to remove adhesives, thin-sets, surface inequalities of +/-4mm and epoxy coatings with thickness of less than 4mm. The #0 Prep Tool is designed to be used as a dry removal tool only. The #0 Prep Tool is made for use on concrete and should never be chosen to grind terrazzo, marble, or granite. The concrete profile after using the #0 Prep Tool will be one that is consistently scratched and resembles 80 grit sand paper. Approximate life of the #0 Prep Tool is 30,000 SF/2,787 M<sup>2</sup>.

##### **Execution**

1. Attach the #0 Prep tools to the Prep/Master<sup>®</sup> Machine and place it in operating position. Attach appropriate power\* and vacuum dust collection hose to the Prep/Master<sup>®</sup> machine.
2. With weights in neutral position\*\* or off machine, start the machine and adjust speed to 45Hz (electric) or 2500 RPM (propane).
3. Upon starting the machine, continuously move machine in side-to-side pattern ensuring that machine is will grind the floor evenly. If for any reason the machine cannot be continuously moved, i.e. cord management, adjacent work, obstacles, etc., stop the machine until it can be operated as specified above. Upon satisfactory completion of surface prep, remove machine and vacuum surface clean.

*\* Power source Voltage will vary by P/M machine being used and should be verified for compatibility before connecting machine to it. Dust collection by appropriate vacuum is compulsory as harmful and damaging dust will be produced if dust collection is not used or is of inadequate capacity. The life of the #0 Prep Tool will also be significantly reduced if vacuum is not of appropriate capacity.*

*\*\*The Prep/Master<sup>®</sup> machines all have pocket weights for the purpose of varying the grinding pressure of the machine. It is suggested to begin with the #0 Prep Tool with no added weight to gauge performance. If the tool is not aggressive enough, simply add more weight to the grinding head of P/M Machine to increase grinding pressure. If #0 Prep Tool is too aggressive, simply add more weight to the handle to reduce grinding pressure.*

##### **Flooring Condition Qualifications**

Use of the #0 Prep Tool requires that the surface to be treated is completely dry. For floors that have adhesives or built-up contaminants, a scraping of the floor will improve performance but is not required. As a general rule, it is best to inspect floor BEFORE beginning to note or mark obstacles such as floor drains, protrusions from floor and elevation changes in excess of 4mm.

## Machinery Qualifications

The #0 Prep Tool is designed to attach to and work perfectly with any Substrate Technology Prep/Master® machine. Quantity of #0 Prep Tool will vary by model:

- Prep/Master® 2807/2818LP & P/M Jr.: 6 pieces
- Prep/Master® 2420/2418LP: 12 pieces
- Prep/Master® 3030/3038LP & RC-3030: 12 pieces
- Prep/Master® 4430/4438LP & RC-4430: 24 pieces

## 2) #00 PCD Prep Tool (leaves a rough profile)

### Description



The #00 Prep Tool is a combination PCD/metal bond preparation tool that has the EG attachment system as a standard for use on any P/M machines. The #00 Prep Tool is directional. This means that any set of #00 Prep tools will always contain 50% right-hand tools and 50% left-hand tools. Its uses are to remove adhesives, thin-sets, surface inequalities of +/-4mm and epoxy coatings with thickness of less than 4mm. The #00 Prep Tool is designed to be used as a dry removal tool only.

The #00 Prep Tool is made for use on concrete and should never be chosen to grind terrazzo, marble, or granite. The concrete profile after using the #00 Prep Tool will be one that is considered rough to the touch having up to 1mm deep grooves. Approximate life of the #00 Prep Tool is 30,000SF / 2,787 M<sup>2</sup>.

### Execution

1. Attach the #00 Prep tools to the P/M machine by placing the right-hand tools (#00R) in the tool holders that are turning clockwise and the left-hand tools (#00L) in the tool holders that are turning counter-clockwise.
2. Place the P/M machine in the operating position. Attach appropriate power\* and vacuum dust collection hose to the P/M machine.
3. With weights in neutral position\*\* or off machine, start the machine and adjust speed to 40Hz (electric) or 2500 RPM (propane).
4. Upon starting the machine, continuously move machine in side-to-side pattern ensuring that machine is continuously moved while running. If for any reason the machine cannot be continuously moved, i.e. cord management, adjacent work, obstacles, etc., stop the machine until it can be operated as specified above.
5. Upon satisfactory completion of surface prep, remove P/M machine and vacuum clean surface.

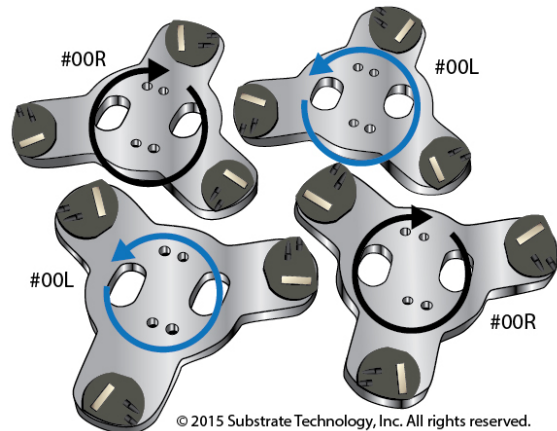

\* Power source voltage will vary by P/M machine being used and should be verified for compatibility before connecting machine to it. Dust collection by appropriate vacuum is compulsory as harmful and damaging dust will be produced if dust collection is not used or is of inadequate capacity. The life of the #00 Prep Tool will also be significantly reduced if vacuum is not of appropriate capacity.

\*\* The Prep/Master® machines all have pocket weights for the purpose of varying the grinding pressure of the machine. It is suggested to begin with the #00 Prep Tool with no added weight to gauge performance. If the tool is not aggressive enough, simply add more weight to the grinding head of P/M machine to increase grinding pressure. If #00 Prep Tool is too aggressive, simply add more weight to the handle to reduce grinding pressure.

### Flooring Condition Qualifications

Use of the #00 Prep Tool requires that the surface to be treated is completely dry. For floors that have excessive adhesives or built-up contaminants, a scraping of the floor will improve performance, but is not required. As a general rule, it is best to inspect floor BEFORE beginning to note or mark obstacles such as floor drains, protrusions from floor, and elevation changes in excess of 4mm.

### Machinery Qualifications

The #00 Prep Tool is designed to attach to and work perfectly with any Substrate Technology Prep/Master® machine. Quantity of #00 Prep Tool will vary by model:

- Prep/Master® 2807/2818 & P/M Jr.: 3 Right-Hand (#00R), 3 Left-Hand (#00L)
- Prep/Master® 2420/2418: 6 Right-Hand (#00R), 6 Left-Hand (#00L)
- Prep/Master® 3030/3038 & RC-3030: 6 Right-Hand (#00R), 6 Left-Hand (#00L)
- Prep/Master® 4430/4438 & RC-4430: 12 Right-Hand (#00R), 12 Left-Hand (#00L)

## 9.2 Polished Concrete - EGT Polishing System (Dry Steps)

The EGT Diamond System is a coordinated metal and resin bonded diamond system to produce a polished concrete floor using any of the eight models of P/M machines. The system is only to be used dry and in sequence as numbered by tools #1 through #8. All tools are painted green or use green velcro backings to indicate a matched system.

### EGT #1 & #2



These are metal bond tools that have the same face design and can be clearly identified by the number on back as “#1” and “#2.” Both tools feature the patented EG attachment system. Approximate life of #1 is 30,000 SF / 2,787 M<sup>2</sup> for all P/M Machines except 4430 (P/M Machine 4430 life expectancy is 40,000 SF / 3,716 M<sup>2</sup>) Approximate life of #2 is 35,000 SF / 3,251 M<sup>2</sup> for all P/M Machines except 4430 (P/M Machine 4430 life expectancy is 47,000 SF / 4,366 M<sup>2</sup>)



### EGT #3



This is a metal bond tool that has the pictured face design and can be clearly identified by the number on back as “#3.” This tool features the patented EG attachment system. Approximate life of #3 is 35,000 SF / 3,251 M<sup>2</sup> for all P/M Machines except 4430 (P/M Machine 4430 life expectancy is 47,000 SF / 4,366 M<sup>2</sup>)

### EGT #4



This is a 3” resin bonded tool that has the pictured face design and can be clearly identified by the number on back as “#4.” This tool features green Velcro backing. Approximate life of #4 is 20,000 SF / 1,858 M<sup>2</sup> for all P/M Machines except 4430 (P/M Machine 4430 life expectancy is 26,500 SF / 2,650 M<sup>2</sup>)

### EGT #5, #6, #7, & #8



#5, #6, #7 & #8 are 3” resin bonded tools that have the pictured face design and can be clearly identified by the number on back as “#5,” “#6,” “#7,” “#8.” These tools feature green Velcro backing. Approximate life of #5, #6, and #8 is 12,000 SF / 1,115 M<sup>2</sup> for all P/M Machines except 4430 (P/M Machine 4430 life expectancy is 16,000 SF / 1,486 M<sup>2</sup>). Approximate life of #7 is 10,000 SF / 930 M<sup>2</sup> for all P/M Machines except 4430 (P/M Machine 4430 life expectancy is 13,300 SF / 1,235 M<sup>2</sup>)



### **Execution of EGT Polishing System**

1. Attach the EGT #1 tools to the P/M Machine and place it in operating position. Attach appropriate power\* and vacuum dust collection hose to the P/M machine. With 50% of weights on head of machine and 50% in basket over wheels, set speed to 35Hz on VSD and start machine (for propane, run at 2200 RPM). Upon satisfactory completion of step #1, remove machine from area and vacuum the surface.
2. Attach the EGT #2 tools to the P/M Machine and place it in operating position. Attach appropriate power\* and vacuum dust collection hose to the P/M machine. With 100% of weights on head of machine, set speed to 35Hz on VSD and start machine (for propane, run at 2200 RPM). Upon satisfactory completion of step #2, remove machine from area and vacuum the surface.
3. Attach the EGT #3 tools to the P/M Machine and place it in operating position. Attach appropriate power\* and vacuum dust collection hose to the P/M machine. With 100% of weights on head of machine, set speed to 35Hz on VSD and start machine (for propane, run at 2200 RPM). Upon satisfactory completion of step #3, remove machine from area and vacuum the surface.
4. Attach the EGT #4 tools to the P/M Machine and place it in operating position. Attach appropriate power\* and vacuum dust collection hose to the P/M machine. With 100% of weights on head of machine, set speed to 35Hz on VSD and start machine (for propane, run at 2200 RPM). Upon satisfactory completion of step #4, remove machine from area and vacuum the surface.
5. Attach the EGT #5 tools to the P/M Machine and place it in operating position. Attach appropriate power\* and vacuum dust collection hose to the P/M machine. With 100% of weights on head of machine, set speed to 45Hz on VSD and start machine (for propane, run at 2500 RPM). Upon satisfactory completion of step #5, remove machine from area and vacuum the surface.
6. Apply densifier per manufacturer's recommendations and allow surface to dry completely after densifier process has been completed. See Section 3 for further information about densifiers.
7. Attach the EGT #6 tools to the P/M Machine and place it in operating position. Attach appropriate power\* and vacuum dust collection hose to the P/M machine. With 100% of weights on head of machine, set speed to 50Hz on VSD and start machine (for propane, run at 2700 RPM). Upon satisfactory completion of step #6, remove machine from area and vacuum the surface.
8. Attach the EGT #7 tools to the P/M Machine and place it in operating position. Attach appropriate power\* and vacuum dust collection hose to the P/M machine. With 100% of weights on head of machine, set speed to 50Hz on VSD and start machine (for propane, run at 2700 RPM) Upon satisfactory completion of step #7, remove machine from area and vacuum the surface.
9. Attach the EGT #8 tools to the P/M Machine and place it in operating position. Attach appropriate power\* and vacuum dust collection hose to the P/M machine. With 100% of weights on head of machine, set speed to 50Hz on VSD and start machine (for propane, run at 2700 RPM). Upon satisfactory completion of step #8, remove machine from area and vacuum the surface.

### **Qualifications**

As a general rule for all operations using the Prep/Master® machines:

- The machine manual MUST be read and understood by any operator for the safe and productive use of the machine.
- Upon starting the machine, continuously move the machine in a side-to-side pattern ensuring that the machine will grind the floor evenly. If for any reason the machine cannot be continuously moved, i.e. cord management, adjacent work, obstacles, etc., stop the machine until it can be operated as specified.

- A thorough processing of the concrete can only be achieved by one pass forward and then a second pass backward over same path. It is compulsory to overlap paths by at least 25%. The machine must always be swung side-to-side approximately 30 degrees. The machine should never be quickly pushed across floor to move to areas outside the area that is to be polished.
- The work area must be closed to all non-associated workers and equipment. The likelihood of contamination by non-associated traffic is increased and rogue scratches will be possible as well as overall reduced polish.

### **Flooring Condition Qualifications**

- Use of the EGT Diamond System requires that the surface to be treated is completely dry. For floors that have adhesives, built-up contaminants or other coatings, the surface must be first prepared using the #0 Prep Tool.
- Use of the EGT tools System can only be used, as specified above, for floors that are at least 4,250Psi/29Mpa and are over 28 days old.
- As a general rule, it is best to inspect floor BEFORE beginning to note or mark obstacles such as floor drains, protrusions from floor and elevation changes in excess of 2mm.
- Any polishing project that is undertaken should ALWAYS be preceded by a mock-up of at least 100 SF / 9 M<sup>2</sup>. This mock-up will serve two purposes: to provide a finished sample that owner can approve and to verify the suitability of the EGT Diamond System for the given slab.

### **Machinery Qualifications**

The EGT Diamond System is designed to attach to and work perfectly with any Substrate Technology Prep/Master<sup>®</sup> machine. Quantity of EGT tools will vary by model:

- Prep/Master<sup>®</sup> 2807/2818LP & P/M Jr.: 6 pieces
- Prep/Master<sup>®</sup> 2420/2418LP: 12 pieces
- Prep/Master<sup>®</sup> 3030/3038LP & RC-3030: 12 pieces
- Prep/Master<sup>®</sup> 4430/4438LP & RC-4430: 24 pieces

Attachment of EGT tools #4 through #8 require Velcro pad adapters #570000031 & #570000026.

### **Densifier Qualifications**

Manufacturer's instructions for use must be followed exactly for best results and to avoid any costly mistakes. Densifier must be the type that after its application, the floor is specified to be finished with a dry system and no water whatsoever.

---

## **9.3 Polished Concrete - CLC Polishing System (Dry-Wet-Dry Steps)**

---

The CLC Diamond System is a coordinated metal and resin bonded diamond system to perform polished concrete using any of the eight models of P/M machines.

The CLC Diamond System is only to be used dry for step #1, wet for steps #2, #3 & #4 and dry for steps #5, #6 & #7 and in sequence as numbered by tools #1 through #7. All tools are painted red or use red Velcro to indicate a matched system.

### **CLC #1**



CLC #1 is a metal bond tool painted red that has pictured face design and can be clearly identified by the number on back as "#1." This tool features the patented EG attachment system. The tool is run dry. Approximate life of #1 is 30,000 SF / 2,787 M<sup>2</sup>.

### **CLC #2**



#2 is a metal bond tool painted red that has pictured face design and can be clearly identified by the number on back as "#2." This tool features the patented EG attachment system. The tool is run wet. Approximate life of #2 is 30,000 SF / 2,787 M<sup>2</sup>.

**CLC #3**



#3 is a 3” resin bonded tool that has the pictured face design and can be clearly identified by the number on back as “#3.” This tool features red Velcro backing. The tool is run wet. Approximate life of #3 is 15,000 SF / 1,394 M<sup>2</sup>.

**CLC #4**



#4 is a 3” resin bonded tool that has the pictured face design and can be clearly identified by the number on back as “#4.” This tool features red Velcro backing. The tool is run wet. Approximate life of #4 is 15,000 SF / 1,394 M<sup>2</sup>.

**CLC #5, #6, & #7**

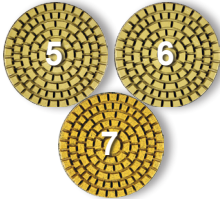

#5, #6 & #7 are 3” resin bonded tools that each have the pictured face design and can be clearly identified by the number on back as “#5”, “#6” & “#7.” These tools feature red Velcro backing. The tool is run dry. Approximate life of #5 & #7 is 12,000 SF / 1,115 M<sup>2</sup> each. Approximate life of #6 is 10,000 SF / 930 M<sup>2</sup> each.

**Execution of CLC Polishing System**

1. Attach the CLC #1 tools to the P/M machine and place it in operating position. Attach appropriate power\* and vacuum dust collection hose to the P/M machine. With 50% of weights on head of machine and 50% in basket over wheels, set speed to 35Hz on VSD and start machine (for propane, run at 2200 RPM). Upon satisfactory completion of step #1, remove machine from area and vacuum the surface.
2. Attach the CLC #2 tools to the P/M machine and place it in operating position. Attach appropriate power\* to the P/M machine. With 50% of weights on head of machine and 50% in basket over wheels, set speed to 45Hz on VSD and start machine (for propane, run at 2500 RPM), add water and start the machine. Upon satisfactory completion of step #2, remove machine from area and wet vacuum or auto-scrub the concrete clean.
3. Apply densifier per manufacturer’s recommendations and allow surface to dry completely after densifier process has been completed. See Section 3 for further information about densifiers.
4. Attach the CLC #3 tools to the P/M machine and place it in operating position. Attach appropriate power\* to the P/M machine. With 50% of weights on head of machine and 50% in basket over wheels, set speed to 45Hz on VSD, add water, and start machine (for propane, run at 2500 RPM). Upon satisfactory completion of step #3, remove machine from area and wet vacuum or auto-scrub the concrete clean.
5. Attach the CLC #4 tools to the P/M machine and place it in operating position. Attach appropriate power\* to the P/M machine. With 50% of weights on head of machine and 50% in basket over wheels, set speed to 45Hz on VSD and start machine (for propane, run at 2500 RPM), add water and start the machine. Upon satisfactory completion of step #4, remove machine from area and wet vacuum or auto-scrub the concrete clean.
6. Attach the CLC #5 tools to the P/M machine and place it in operating position. Attach appropriate power\* and vacuum dust collection hose to the P/M machine. With 100% of weights on head of machine, set speed to 50Hz on VSD and start machine (for propane, run at 2700 RPM). Upon satisfactory completion of step #5, remove machine from area and vacuum the surface.
7. Apply densifier per manufacturer’s recommendations and allow surface to dry completely after densifier process has been completed. See Section 3 for further information about densifiers.
8. Attach the CLC #6 tools to the P/M machine and place it in operating position. Attach appropriate power\* and vacuum dust collection hose to the P/M machine. With 100% of weights on head of machine, set speed to 50Hz on VSD and start machine (for propane, run at 2700 RPM). Upon satisfactory completion of step #6, remove machine from area and vacuum the surface.

9. Attach the CLC #7 tools to the P/M machine and place it in operating position. Attach appropriate power\* and vacuum dust collection hose to the P/M machine. With 100% of weights on head of machine, set speed to 50Hz on VSD and start machine (for propane, run at 2700 RPM). Upon satisfactory completion of step #7, remove machine from area and vacuum the surface.

### **Qualifications**

As a general rule for all operations using the Prep/Master® machines:

- The machine manual MUST be read and understood by any operator for the safe and productive use of the machine.
- The use of the machine and water must only be done by skilled workers that have been trained and understand the safety precautions that need to be undertaken. The danger of electric shock is present anytime water is used with electrical machinery. Water also presents the possibility that any floor openings or drains can serve as a conduit for water to damage unintended areas. The disposal of wet waste or slurry must be done in accordance with all local laws and regulations.
- Upon starting the machine, continuously move machine in side-to-side pattern ensuring that machine is continuously moved while running. If for any reason the machine cannot be continuously moved, i.e. cord management, adjacent work, obstacles, etc., stop the machine until it can be operated as specified.
- A thorough processing of the concrete can only be achieved by one pass forward and then second pass backward over same path. It is compulsory to overlap paths by at least 25%. The machine must always be swung side-to-side approximately 30 degrees. The machine should never be quickly pushed across floor to move to areas outside the area that is to be polished.
- The work area must be closed to all non-associated workers and equipment. The likelihood of contamination by non-associated traffic is increased and rogue scratches will be possible as well as overall reduced polish.

### **Flooring Condition Qualifications**

Use of the CLC Diamond System requires that the surface to be treated is clean of coatings or adhesives. For floors that have adhesives, built-up contaminants or other coatings, the surface must be first prepared using the #0 Prep Tool.

Use of the CLC Diamond System can only be used, as specified above, for floors that are at least 4,250Psi/29Mpa and are over 28 days old.

As a general rule, it is best to inspect floor BEFORE beginning to note or mark obstacles such as floor drains, protrusions from floor and elevation changes in excess of 2mm.

Any polishing project that is undertaken should ALWAYS be preceded by a mock-up of at least 100 SF / 9 M<sup>2</sup>. This mock-up will serve two purposes: to provide a finished sample that owner can approve and to verify the suitability of the CLC Diamond System for the given slab.

### **Machinery Qualifications**

The CLC Diamond System is designed to attach to and work perfectly with any Substrate Technology Prep/Master® machine. Quantity of CLC tools will vary by model:

- Prep/Master® 2807/2818LP & P/M Jr.: 6 pieces
- Prep/Master® 2420/2418LP: 12 pieces
- Prep/Master® 3030/3038LP & RC-3030: 12 pieces
- Prep/Master® 4430/4438LP & RC-4430: 24 pieces

Attachment of CLC tools #3 through #7 require Velcro pad adapters 570000031 & 570000026.

**Densifier Qualifications**

Manufacturer’s instructions for use must be followed exactly for best results and to avoid any costly mistakes. Densifier must be type, that after its application, the floor is specified to be finished with a dry system and no water whatsoever.

**9.4 Terrazzo Polishing - TPS Polishing System (Dry-Wet Steps)**

The TPS System is a coordinated metal and resin bonded diamond system to perform grinding and polishing of new Epoxy Terrazzo using any of the eight models of P/M machines.

The TPS System is only to be used dry for steps #1, #2 & #3 and wet only for steps #4, #5, #6 & #7 and in sequence as numbered by tools #1 through #7. All tools are painted orange or use orange Velcro to indicate a matched system.

Since a portion of the TPS System is performed wet, its use should only be by those familiar with all safety and productive work practices while using water.

**TPS #1**



#1 is a metal bond tool painted orange that has pictured face design and can be clearly identified by the number on back as “#1.” This tool features the patented EG attachment system. The tool is run dry. Approximate life of #1 is 12,000 SF / 1,115 M<sup>2</sup> for all P/M Machines except 4430. (P/M Machine 4430 life expectancy is 15,500 SF / 1,440 M<sup>2</sup>.)

This tool is the first cut tool for Epoxy Terrazzo rough cut step. The #1 TPS tool life will be variable based upon Epoxy Terrazzo mixture components, consistency of epoxy terrazzo placement, and adequate dust collection.

**TPS #2**



#2 is a metal bond tool painted orange that has pictured face design and can be clearly identified by the number on back as “#2.” This tool features the patented EG attachment system. The tool is run dry. Approximate life of #2 is 30,000 SF / 2,787 M<sup>2</sup> for all P/M Machines except 4430. (P/M Machine 4430 life expectancy is 40,000 SF / 3,716 M<sup>2</sup>.)

**TPS #3**



#3 is a metal bond tool painted orange that has pictured face design and can be clearly identified by the number on back as “#3.” This tool features the patented EG attachment system. The tool is run dry. Approximate life of #3 is 30,000 SF / 2,787 M<sup>2</sup> for all P/M Machines except 4430. (P/M Machine 4430 life expectancy is 40,000 SF / 3,716 M<sup>2</sup>.)

**TPS #3.5 (Grout Pan)**



Grout Pan #3.5 is a patent pending stainless steel tool that has the pictured face design and can be clearly identified by the stamping on back Velcro as “#3.5” This tool features orange Velcro backing. The tool is run with epoxy and marble flour (calcium carbonate powder). Approximate life of #3.5 is 10,000 SF / 929 M<sup>2</sup>. (See execution for more details.)

**TPS #4**



#4 is a resin bonded tool that has the pictured face design and can be clearly identified by the number on back as “#4.” This tool features orange Velcro backing. The tool is run wet. Approximate life of #4 is 15,000 SF / 1,394 M<sup>2</sup> for all P/M Machines except 4430. (P/M Machine 4430 life expectancy is 20,000 SF / 1,858 M<sup>2</sup>.)

**TPS #5, #6, & #7**

#5, #6 & #7 are resin bonded tools that have the pictured face design and can be clearly identified by the numbers on back as “#5,” “#6,” & “#7.” These tools feature orange Velcro backing. The tools are run wet. Approximate life of #5, #6 & #7 are 15,000 SF / 1,440 M<sup>2</sup> for all P/M Machines except 4430. (P/M Machine 4430 life expectancy is 20,000 SF / 1,858 M<sup>2</sup> each.)

**Execution of TPS Polishing System**

1. Attach the TPS #1 tools to the P/M Machine and place it in operating position. Attach appropriate power\* and vacuum dust collection hose to the P/M machine. With 100% of weights on head of machine, set speed to 40Hz on VSD and start machine (for propane, run at 2350 RPM). Upon satisfactory completion of step #1, remove machine from area and vacuum the surface.
2. Attach the TPS #2 tools to the P/M Machine and place it in operating position. Attach appropriate power\* to the P/M machine. With 100% of weights on head of machine, set speed to 40Hz on VSD and start machine (for propane, run at 2350 RPM). Upon satisfactory completion of step #2, remove machine and vacuum clean.
3. Attach the TPS #3 tools to the P/M Machine and place it in operating position. Attach appropriate power\* to the P/M machine. With 100% of weights on head of machine, set speed to 40Hz on VSD and start machine (for propane, run at 2350 RPM). Upon satisfactory completion of step #3, remove machine and vacuum clean.
4. Grout the floor with approved epoxy grouting material by either traditional method using marble flour (calcium carbonate powder) and a steel trowel, or with the STI Grout Pans (TPS #3.5) on P/M machine (or similar rotary machine) with marble flour. Let dry a minimum of eight hours. *Please note: the STI Grout Pans can only be run on the P/M machine at 15Hz or 2100 RPM with the pocket weights on the handle. Not running as recommended will greatly reduce pan life expectancy and may produce burn marks in the floor. Never use the pans on machines that have RPM in excess of 250RPM tool speed.*
5. Attach the TPS #4 tools to the P/M Machine and place it in operating position. Attach appropriate power\* to the P/M machine. With 50% of weights on head of machine and 50% in basket over wheels, set speed to 45Hz on VSD and start machine (for propane, run at 2500 RPM). Upon satisfactory completion of step #4, remove machine from area and wet vacuum or auto-scrub the concrete clean.
6. Attach the TPS #5 tools to the P/M Machine and place it in operating position. Attach appropriate power\* to the P/M machine. With 50% of weights on head of machine and 50% in basket over wheels, set speed to 45Hz on VSD and start machine (for propane, run at 2500 RPM). Upon satisfactory completion of step #5, remove machine from area and wet vacuum or auto-scrub the concrete clean.
7. Attach the TPS #6 tools to the P/M Machine and place it in operating position. Attach appropriate power\* to the P/M machine. With 50% of weights on head of machine and 50% in basket over wheels, set speed to 45Hz on VSD and start machine (for propane, run at 2500 RPM). Upon satisfactory completion of step #6, remove machine from area and wet vacuum or auto-scrub the concrete clean.
8. Attach the TPS #7 tools to the P/M Machine and place it in operating position. Attach appropriate power\* to the P/M machine. With 50% of weights on head of machine and 50% in basket over wheels, set speed to 45Hz on VSD and start machine (for propane, run at 2500 RPM). Upon satisfactory completion of step #7, remove machine from area and wet vacuum or auto-scrub the concrete clean.

**Qualifications**

As a general rule for all operations using the Prep/Master® machines:

- The machine manual MUST be read and understood by any operator for the safe and productive use of the machine.

- The use of the machine and water must only be done by skilled workers that have been trained and understand the safety precautions that need to be undertaken. The danger of electric shock is present anytime water is used with electrical machinery. Water also presents the possibility that any floor openings or drains can serve as a conduit for water to damage unintended areas. The disposal of wet waste or slurry must be done in accordance with all local laws and regulations.
- Upon starting the machine, continuously move the machine in a side-to-side pattern ensuring that the machine will grind the floor evenly. If for any reason the machine cannot be continuously moved, i.e. cord management, adjacent work, obstacles, etc., stop the machine until it can be operated as specified.
- When cutting a new epoxy terrazzo floor, installation flatness will affect production greatly. The TPS #1 tool is specified as the “first cut” tool since it is the most aggressive in the system and designed to quickly remove floor stock. As such, any new floor must be ground to full aggregate exposure using the TPS #1 tools before commencing with subsequent steps. Being that subsequent steps are finer than #1, these tools cannot be expected to perform any more aggregate exposure; only to remove scratches from previous steps.
- A thorough processing of the epoxy terrazzo can only be achieved by one pass forward and then second pass backward over same path. It is compulsory to overlap paths by at least 25%. The machine must always be swung side-to-side approximately 30 degrees. The machine should never be quickly pushed across floor to move to areas outside the area that is to be polished.
- The work area must be closed to all non-associated workers and equipment. The likelihood of contamination by non-associated traffic is increased and rogue scratches will be possible as well as overall reduced polish.

### ***Flooring Condition Qualifications***

Use of the TPS Diamond System requires that the epoxy terrazzo floor is at least eight hours old. As a general rule, it is best to inspect floor BEFORE beginning to note or mark obstacles such as floor drains, protrusions from floor.

Any polishing project that is undertaken should ALWAYS be preceded by a mock-up of at least 100 SF / 9 M<sup>2</sup>. This mock-up will serve two purposes: to provide a finished sample that owner can approve.

### ***Machinery Qualifications***

The TPS Diamond System is designed to attach to and work perfectly with any Substrate Technology Prep/Master<sup>®</sup> machine. Quantity of TPS tools will vary by model:

- Prep/Master<sup>®</sup> 2807/2818LP & P/M Jr.: 6 pieces
- Prep/Master<sup>®</sup> 2420/2418LP: 12 pieces
- Prep/Master<sup>®</sup> 3030/3038LP & RC-3030: 12 pieces
- Prep/Master<sup>®</sup> 4430/4438LP & RC-4430: 24 pieces

Attachment of TPS tools #4 through #7 require Velcro pad adapters 570000031 & 570000026.



*Service • Support • Success*

Substrate Technology, Inc.  
1384 Bungalow Rd.  
Morris, IL 60450 USA  
+1.815.941.4800  
+1.815.941.4600 Fax  
[www.substratetechnology.com](http://www.substratetechnology.com)