

**P/M**® It's a System  
Not a Machine



Service • Support • Success

# Operating Manual

# Prep/Master® Jr.

Item # 823752201



---

# Table of Contents

---

1.0	Technical Data . . . . .	1
2.0	Safety Instructions . . . . .	3
3.0	General Information . . . . .	8
4.0	Transportation. . . . .	14
5.0	Starting Up the Machine. . . . .	16
6.0	Operation of the Machine. . . . .	18
7.0	Maintenance . . . . .	20
8.0	Troubleshooting / Diagnostics . . . . .	22
9.0	Electric Circuit Schematics . . . . .	27
10.0	STI Reference Guide & Procedures . . . . .	29



---

***Please note: The following safety instructions must be followed as shown in this operating manual. Failure to do so may result in hazard to health or possible death.***

---

## **Prep/Master® Warranty**

Substrate Technology guarantees that its machines and products are without manufacturing defects. The warranty period on machines is one (1) year from the date of sale and the variable speed drive carries a two (2) year warranty from the date of sale. Substrate Technology will replace any part that is defective at its own cost within the warranty period. This warranty does not cover wear items or instances of abuse or neglect.



Substrate Technology, Inc.  
1384 Bungalow Rd.  
Morris, IL 60450 USA  
+1.815.941.4800  
+1.815.941.4600 Fax  
[www.SubstrateTechnology.com](http://www.SubstrateTechnology.com)

[02.2019]

## 1.0 Technical Data

- 1.1 Rating
- 1.2 Unit Specifications: Prep/Master® Jr.
- 1.3 Operative Range and Correct Usage
- 1.4 Stand-by Power Supply
- 1.5 Advice for Operators of Grinding Machines
- 1.6 Machine Type Designation

### 1.1 Rating

Machine:	Prep/Master® Grinder
Machine-Type:	Prep/Master® Jr.
Manufacturer:	Substrate Technology 1384 Bungalow Rd. Morris IL 60450 USA +1.815.941.4800 www.substratetechnology.com

### 1.2 Unit Specifications: Prep/Master® Jr.

#### ***Dimensions:***

Length	50 in (127 cm)
Width	23 in (58 cm)
Height	48 in (122 cm)
Weight ( <i>with pocket weights</i> )	455 lbs. (206 kg)

#### ***Connected loads of the electrical system:***

Motor HP	7.5 HP   5.6 kW
Inverter HP	15 HP   11 kW
Voltage	220-240V Single Phase
Amperage	40A
Tool Speed	250-500 RPM

---

### **1.3 Operative Range and Correct Usage**

---



*The Prep/Master® Jr. is designed to be used on clean, dry or wet horizontal surfaces without obstacles. The machine cannot be used for other purposes. The manufacturer will not be liable for damages resulting from such incorrect usage. In case of wrong usage the user is responsible for all damages.*

---

---

---

### **1.4 Stand-by Power Supply (Generator)**

---



*If the Prep/Master® Jr. is operated using a generator, the generator must be operated in accordance with the current local electrical directives (this applies especially to the protective ground conductor) in order to ensure that all safety devices are functioning and to be able to eliminate possible damage to electrical components.*

---

---

---

### **1.5 Advice for Operators of Grinding Machines**

---



*During the operation of the Prep/Master® Jr. it may be possible to exceed the acceptable noise level of 85 dB(A). This is dependent on the different locations and the local circumstances. When the noise level is 85 dB(A) or more, the machine operator and others working near the machine must wear sound-insulating devices.*

---

---

---

### **1.6 Machine Type Designation**

---

Machine Type:	Prep/Master® Jr.
Working Width:	23 in (58 cm)
Drive:	Manual
Grinding Capacity:	Variable
Dust Hose Connection:	2 in (50mm)
Water Tank	8 gal. (30 liters)
Tool Plates (2)	12" plates
Pocket Weights (32 lbs. each)	2
EG Diamonds Needed	6

---

## 2.0 Safety Instructions

---

- 2.1 Explanation of Warnings and Symbols
- 2.2 Organizational Measures
- 2.3 Personnel Selection and Qualification
- 2.4 Safety Precautions Applicable to Different Operating Conditions
- 2.5 Repair Work, Maintenance Activities, and Default Repair on the Job Site
- 2.6 Definition of the Safety-off Position
- 2.7 Dangerous Aspects of the Machine
- 2.8 Electrical Engineering Regulations
- 2.9 Special Instructions



***The following safety instructions must be followed as shown here. Failure to do so may result in hazard to health or possible death.***

---

### 2.1 Explanation of Warnings and Symbols

---

***The following symbols are used in the operating instructions to highlight areas of particular importance:***

#### **Operational Safety**



This symbol will be shown in these Operating Instructions next to all safety precautions that are to be taken in order to ensure prevention of injury. Follow these instructions and take special care in these circumstances. In addition to these instructions, the general safety precautions and the local accident prevention guidelines are also to be followed. Please check whether there are special regulations for the particular job site.

#### **Safety Goggles/ Ear Protection**



Information, instructions, and restrictions with regards to possible risks to persons or extensive material damages.

#### **Electrical Warning**



Warning against dangerous voltages.

## 2.2 Organizational Measures



*The Operating Instructions are to be kept near the machine location and must be accessible at all times!*

In addition to the Operating Instructions, general and legal regulations regarding accident prevention and environmental protection must be with and indicated every time. Such duties may, for example, relate to the handling of hazardous substances or to the provision and wearing of personal protection equipment as well as compliance with local traffic regulations.

The Operating Instructions must be supplemented by instructions including the duty to supervise and report relating to particular local working practices, for example, work organization, work procedures, and personnel allocation.

Personnel entrusted with working with the machine must have read the Operating Instructions before starting the work, in particular, the chapter about Safety Instructions. These must be read before starting any work with the machine. This particularly applies to incidental activities such as setting up the machine, carrying out maintenance work, or training staff to work with the machine.

From time to time the working practices of the staff are to be checked regarding awareness of safety and hazards.

Personnel must tie back long hair and not wear loose clothing or jewelry and rings. There is a risk of injury through getting stuck or being drawn into moving machinery.



*Use personal protection equipment if necessary or required by regulations! Take notice of all safety and hazard notices on the machine.*

All safety and hazard notices on the machine must be kept complete and legible.

If critical changes occur to the machine or its performance, the machine must be shut down immediately! The cause of the fault has to be established immediately and has to be repaired before starting the work again.



*Changes, add-ons, or conversions of the machine which might have an influence to the safety of the machine must not be undertaken without the permission of the manufacturer. This applies, in particular, to the fitting and adjustment of safety devices and to welding on major and load bearing parts.*

Spare parts must always comply with the technical requirements and the specifications of the manufacturer. This is always guaranteed with original spare parts of the manufacturer.

Inspection intervals and intervals for recurring checks specified in these Operating Instructions must be complied with. At the same time, it is necessary to meet the legal requirements.

To perform maintenance work correctly it is important to be equipped with proper tools for the task in question.

The location and the operation of fire extinguishers must be made known on each building site. Take note of the facilities for fire reporting and fighting fires.

## 2.3 Personnel Selection and Qualification

### ***Fundamental duties:***

Only reliable, trained, authorized personnel are allowed to work and operate the machine. Note the statutory minimum age! Specify clearly the responsibilities of personnel for operation, setting up, servicing and maintenance work. Define his/her responsibilities also with regard to traffic safety regulations and empower him/her to decline instructions from third parties which are not complying with the safety requirements.

Personnel being trained or made acquainted with the equipment may only be deployed under constant supervision of an experienced person.



*Work on the electrical parts of the equipment may only be undertaken by a skilled electrician or by a trained person under the guidance and supervision of a skilled electrician as well as in accordance with the electrical engineering regulations.*

## 2.4 Safety Precautions Applicable to Different Operating Conditions

Avoid any method of working that impairs safety! All precautions have to be taken so the machine will only be used in a safe and functional status.



*Only operate the machine when all safety devices and related safety equipment, e.g. detachable safety devices, emergency stops, and suction devices, are present and operational!*

The machine has to be checked visually at least once a day for any damage and defects. In the event of operational malfunctions, the machine must be shut down immediately and secured. The fault must be rectified before starting the machine again!



*Secure the work area around the machine in public areas providing a safety distance of at least 10 feet around the machine.*

### ***Fault must be rectified immediately!***

Start up/switch off operations plus any control devices have to be handled in accordance with the Operating Instructions.



*All persons in the proximity of the machine must wear safety glasses with lateral protection as well as safety shoes. Ear protection may be required. The operator is obliged to wear close fitting protective clothing.*

Use only extension cables for extending the main cable that are sized and marked in accordance with the overall power consumption of the machine and the valid local guidelines..

Before starting the machine make sure that no one can be endangered when the machines starts running.



*Do not switch off or remove the exhaust and ventilation devices when the machine is running!*



---

## 2.5 Repair Work, Maintenance Activities, and Default Repair on the Job Site

---



*Before starting any service work on the machine, put the machine in the Safety off position as described in chapter 2.6 in order to prevent the machine from being switched on accidentally.*

---

Please follow any special safety instructions in the chapters on servicing the machine. Adjustments, servicing, and inspection work and inspection intervals specified in these Operating Instructions as well as any information on the replacement on parts and systems of the machine must be undertaken and / or complied with. These activities can only be undertaken by qualified personnel.

During all work related to the use, adjustment of the machine, safety devices, inspection, maintenance, and repair, the start up/shut off procedures have to be done in accordance with these Operating Instructions. For the machine to be shut off completely for repair or maintenance work, the plug has to be disconnected in order to prevent the machine from being switched on accidentally.

The dust bin of a connected dust collector has to be emptied before transportation. Please handle in accordance with the regulation how to dispose the dust and make sure that you meet the local regulations.

Do not use any aggressive cleaning materials! Use lint-free cleaning cloths.

If safety devices need to be dismantled during setting up, servicing, and repair work, these safety devices must be reinstalled and inspected immediately after completion of the servicing and repair work. Always tighten any screw connection that is undone during servicing and maintenance work.

Make sure that process materials and replacement parts are disposed of safely and in an environmentally-friendly manner.



*Work on the electrical parts of the equipment may only be undertaken by a skilled electrician or by a trained person under the guidance and supervision of a skilled electrician as well as in accordance with the electrical engineering regulations. Make sure that electrical components used for replacement purpose comply with the original parts and are correctly adjusted if necessary.*

---

---

## 2.6 Definition of the Safety-off Position

---

### **Definition:**

The safety off position is the position of the machine when it cannot generate any hazard.

### **Putting the machine in the safety-off position means:**

- Switch off the grinder.
- Switch off the dust collector.
- Wait for standstill of all drives.
- Pull out all main plugs.
- Secure the machine against unintended start up.



## 2.7 Dangerous Aspects of the Machine



*Every machine, if it is not used according to the regulations, may be hazardous for operating, setting-up, and service personnel. The operating authority is responsible for compliance with the safety regulations during operation and maintenance of safety devices supplied with the machine as well as the provision of appropriate additional safety devices.*

## 2.8 Electrical Engineering Regulations



*Never start machine in the tilted position. The machine must only be started when all guards and dust collection parts are attached and machine is standing flat on work surface.*



*Work on the electrical parts of the equipment may only be undertaken by a skilled electrician or by a trained person under the guidance and supervision of a skilled electrician as well as in accordance with the electrical engineering regulations.*



*Use only extension cables for extending the main cable that are sized and marked in accordance with the overall power consumption of the machine and the valid VDE guidelines. In cases there is any question, ask the manufacturer or a skilled electrician.*

If work on electrified parts is necessary, a second person must be deployed who can pull out the plug in an emergency. The working area must be sealed with a red and white safety chain and a danger sign. Use tools that are insulated against voltages. Only start work, once you are familiar with the electrical engineering regulations that apply to your area.

Only use voltage testers that comply with the regulations when troubleshooting. From time to time, check the voltage tester to ensure that they are operationally efficient.

## 2.9 Special Instructions

Use only proper and functioning tools for your work. Damaged tools have to be repaired immediately or to be replaced.

Use required safety equipment and safety clothes (e.g. safety glasses, safety shoes, safety gloves).

***Please instruct your operators and repair personnel about the following points:***

- Cleaning and repair work are only allowed if the machine is shut off (safety off position).
- During work on the machine, be certain that the machine cannot be started.
- Opening or removing safety devices while the machine is running are not allowed.
- Replace all safety covers and devices after cleaning, repair, and maintenance work.
- Do not touch moving parts and do not walk into the working path of the machine.
- Before restarting machine, make sure all personnel are a safe distance away from the work area after initial start up.

---

## 3.0 General Information

---

- 3.1 Operative Range
- 3.2 Scope of Supply
- 3.3 Exploded Diagram
- 3.4 Operating Features
- 3.5 Electric Motor
- 3.6 Emergency Stop
- 3.7 Cutting Area
- 3.8 Couplers & Tool Plates
- 3.9 Variable Speed Drive
- 3.10 Tool Change
- 3.11 Care & Maintenance

---

### 3.1 Operative Range

---

The STI Prep/Master® Jr. is a grinding machine with counter-rotating heads that is used for preparation and polishing of horizontal surfaces. Grinding the surface according to STI specifications thoroughly removes surface contaminants, coats of paint, sealants, and thin coatings.

A suitable filter unit must be connected to the machine in order to thoroughly collect the dust being produced by the grinding process. The proper dust collection system ensures dust-free operation of the machine and clean air at the workspace.

---

### 3.2 Scope of Supply

---

***Provided with machine:***

- Prep/Master® Jr.
- Standard Accessories
- Manual (1)

***Sold Separately:***

- 2-inch Vacuum Hose (25 ft.)

3.3 Exploded Diagrams & Part Numbers

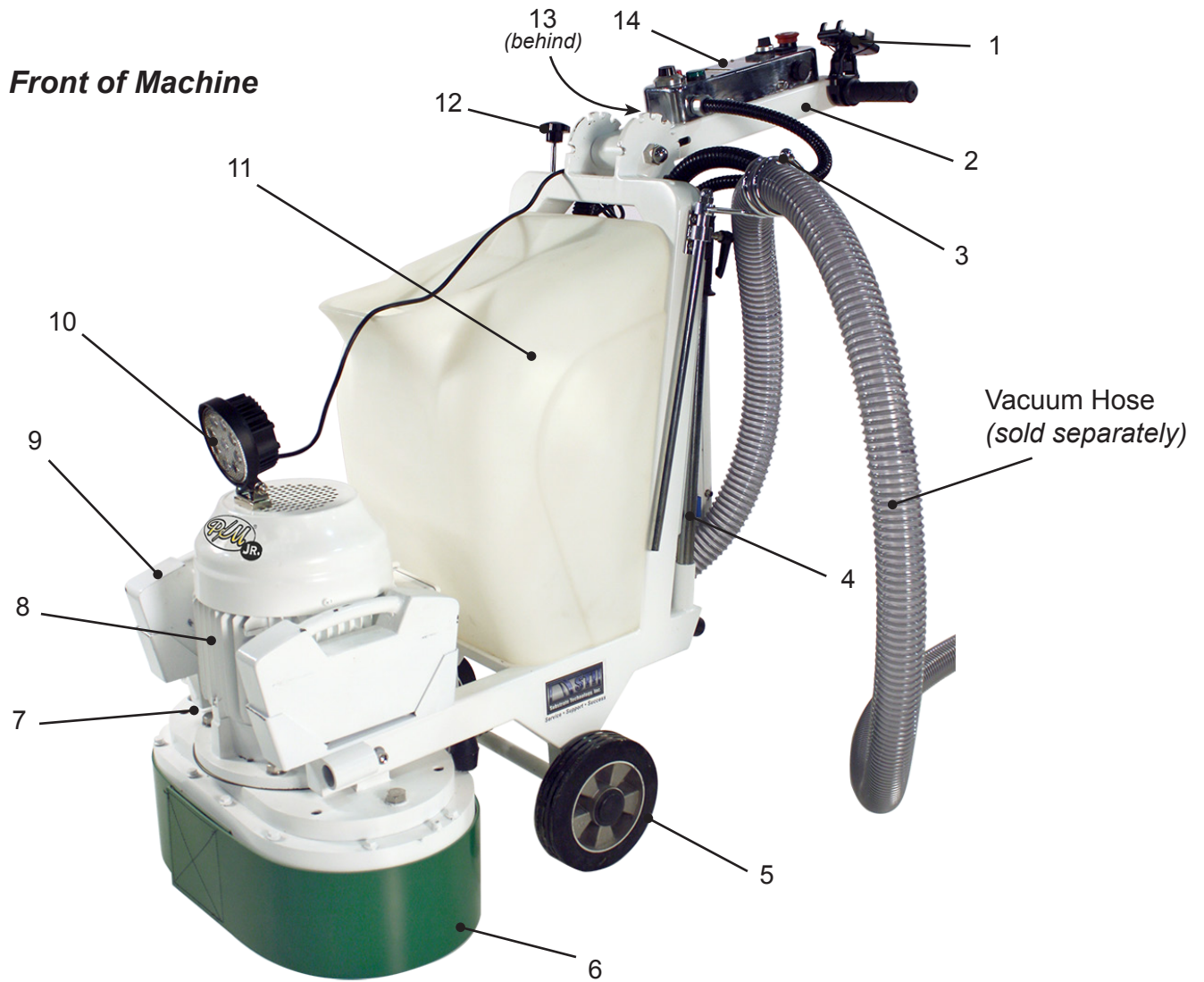

Item #	Qty.	Part #	Description
1	1	823000211	Phone Carrier
2	1	823000208	Upper Handle
3	1	823000201	Hose Rack
4	2	823000202	Carrying Pole
5	2	823000210	Wheel
6	1	823000206	Shroud
7	1	823000204	Breather Valve
8	1	823000103	7.5 HP Motor
9	2	823000205	Pocket Weights - 32 lbs ea. (set of two)
10	1	823000108	LED Light
11	1	823000203	Plastic Water Tank
12	1	823000207	Water Valve
13	1	823000209	Height Adjusting Handlebar
14	1	823000109	Control Panel

**Back of Machine**

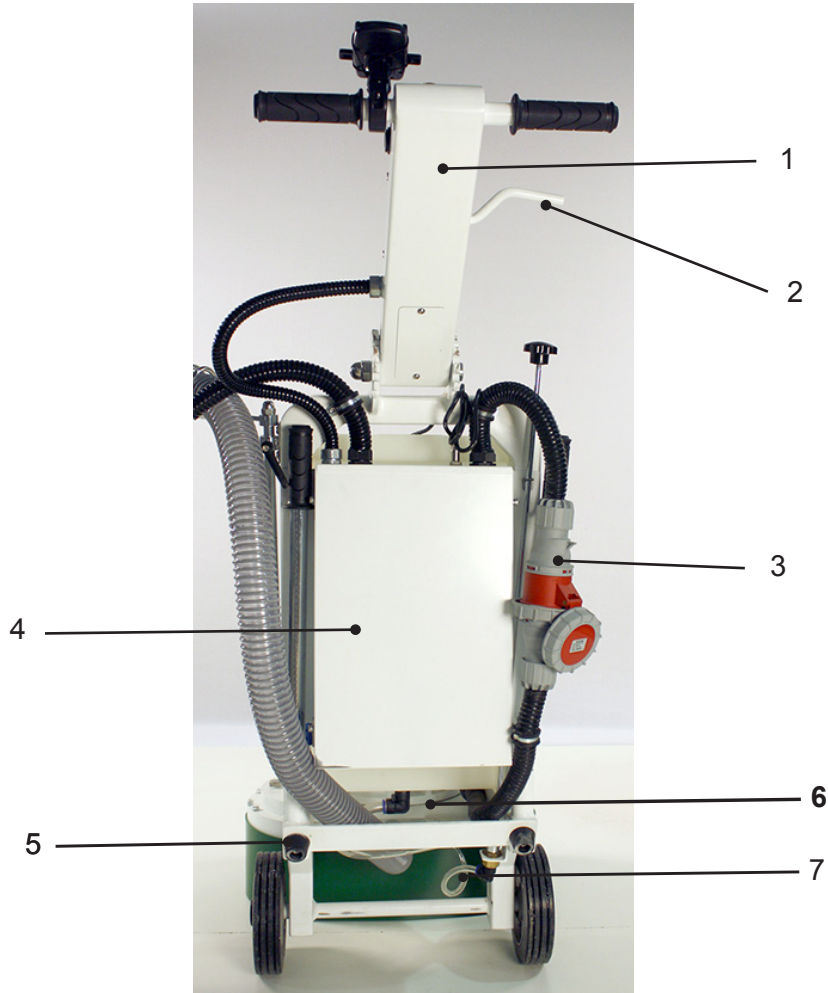

#	Qty.	Part #	Description
1	1	823000208	Upper Handle
2	1	823000209	Height Adjusting Handlebar
3	1	823000111	Plug & Receptacle 32A - Single Phase
4	1	823000101	15 HP Drive - 240V
5	2	823000212	Rubber Feet
6	1	823000223	Water Hose 10" (water tank to the valve)
7	1	823000222	Water Valve Hose, 2 ft (Valve to Gearbox)

**Gear Box**

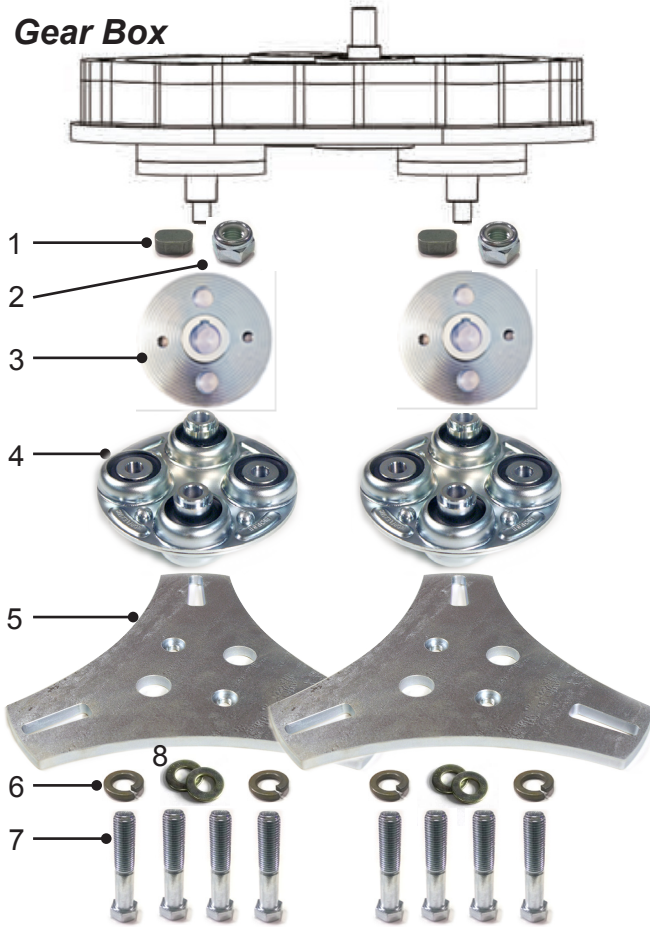

**Control Panel**

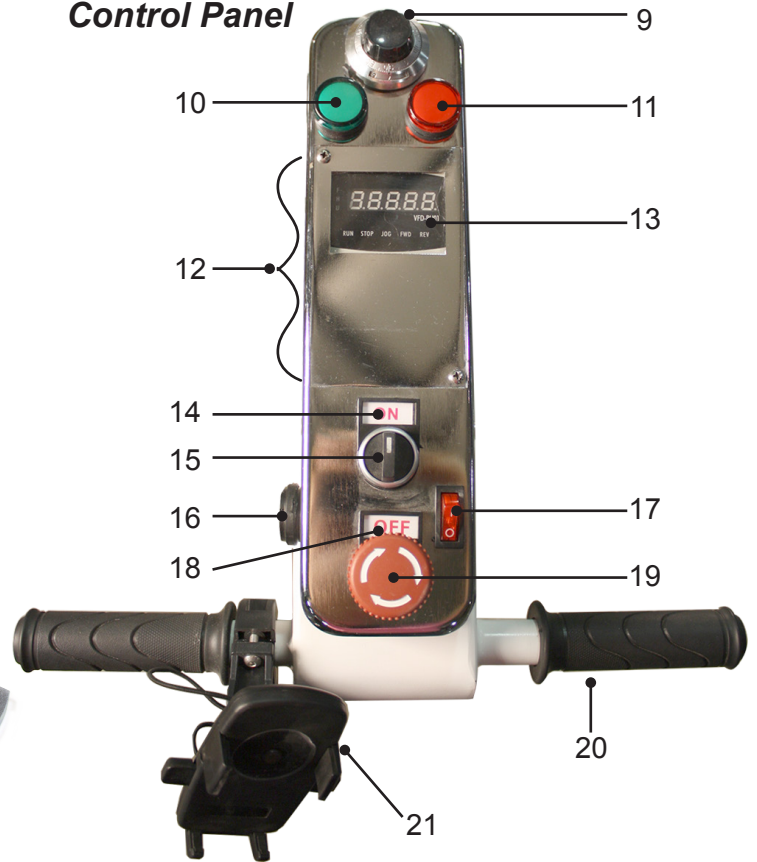

#	Qty.	Part #	Description
1	2	881101886	Woodruff Key
2	2	823826802	M16 Nyloc Nut
3	2	823489502	4 Hole Drive Plate (New Style) <b>**See Comments Below**</b>
4	2	880000502	Morflex Coupler (502)
5	2	823026502	Tool Plate
6	4	1133894	Locking Washer
7	8	17162	7/16" - 20 Bolt - 2¼ in.
8	4	11128612	7/16" Flat Washer <b>**New Style Drive Plates ONLY**</b>
9	1	823000105	Speed Control
10	1	823000114	Power Light (Green)
11	1	823000104	Power Lamp (Red)
12	1	823000109	Control Panel Cover
13	1	823000102	Digital Inverter Display
14	1	823000118	On Indicator
15	1	823000106	Forward and Reverse Black Switch
16	1	823000113	USB Port
17	1	823000110	LED Light Switch
18	1	823000116	Off Indicator
19	1	823000107	Emergency-Stop Button
20	1	823000220	Handle Grip
21	1	823000211	Phone Carrier

Old Style Drive Plate



**\*\*IMPORTANT -- All PM JR's built before August 2020 used a 2 hole Drive plate. These plates use the following hardware: 17162 (7/16x2.25" Bolt) Qty 4 / 17161 (7/16x2" Bolt) Qty 4 / 1133894 (Locking Washer) Qty 4**



**Standard Accessories**

**1. Dust Skirt**

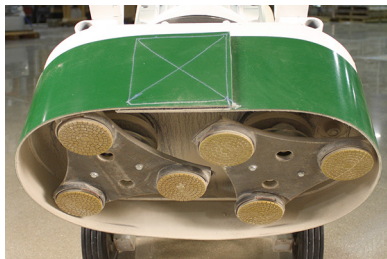

**2. Pocket Weights (2)**



**3. LED Light**



**4. Phone Carrier**



**5. Wire/Hose Rack**



**6. Water Valve**



**7. Carrying Poles (2)**



**8. USB Port**



---

### 3.4 Operating Features

---

The Variable Speed Drive displays all controls and instruments used for supervision and control of the machine.

#### ***Start Switch***

Turns the machine on and off.

#### ***Adjusting Motor Speed***

Adjust motor speed by using the speed dial at top of the control panel. The Speed Dial controls the Hertz of the motor.



---

### 3.5 Electric Motor

---

The power plant of the Prep/Master® Jr. grinder is the electric motor. The motor is responsible for turning the gears which turn the abrasive tools on the floor. The motor is controlled exclusively by the Variable Speed Drive which inputs specific power to generate a given RPM.

---

### 3.6 Emergency Stop

---

Push the red dial down quickly to stop the machine in an emergency.

To release, hold the P/M Jr.'s handle grip tightly and turn the emergency switch clockwise to release the stop feature.



---

### 3.7 Cutting Area

---

The area inside the shroud and directly beneath the gear deck is the cutting area. This is the area in which the tools turn to produce the grinding action. It is also the area that keeps the grinding dust contained and subsequently evacuated through the dust collection port.

---

### 3.8 Couplers & Tool Plates

---

The grinder is outfitted with couplers and tool plates. The couplers attach to the tool plates and provide flexibility for smooth operation of the diamond tools. The tool plate holds the tools in place for the grinding application.

---

### 3.9 Variable Speed Drive

---

The variable speed drive is responsible for monitoring incoming power as well as changing the electronic frequency to allow the motor to run at different speeds. This unit is a closed panel that is intended to be operated only with the dial.

---

### 3.10 Tool Change

---

In order to change the tools, the operator must first ensure that the grinder is switched off and disconnected from the electrical source.



Push machine down by the handle in a controlled manner until the grinder is resting on its handle. The operator then taps the abrasive tools free by forcing toward the center of plate and re-installs with preferred abrasive tool.

Machine must only be tilted back on firm, level surface. There is danger of machine falling if all weights are not used and surface is not level.

Change abrasive state

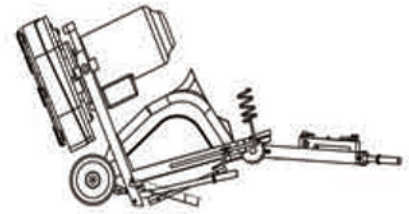

### 3.10 Care & Maintenance

Special attendance and regular maintenance of the machine and its parts are imperative for functioning and safety. In order to prevent unnecessary downtimes it is recommended to keep original spare and wear parts on stock.

***The following maintenance should take place before and after every operation of machine:***

1. Clean all surfaces with a dry, lint free cloth.
2. Inspect all electrical cables/wires for cuts and replace damaged cords.
3. Check all electrical connections are secure and snug.
4. Inspect gear box for any signs of oil leakage and repair as required.



*All persons in the proximity of the machine in operation must wear safety glasses with lateral protection and safety shoes. The machine operator must wear close-fitting protective clothing.*

## 4.0 Transportation Instructions

- 4.1 General Notes
- 4.2 Transportation
- 4.3 Transportation by Vehicle
- 4.4 Procedure for Disassembly of Prep/Master® Jr.
- 4.5 Operation Conditions

### 4.1 General Notes

Before the machine used for the first time, STI authorized dealers offer instruction to familiarize maintenance and operating personnel with all elements of the machine. We are not liable for damage caused by incorrect use of the machine by personnel not trained by STI.

Always place the machine handle in the front tilted position when transporting.

Transportation mode

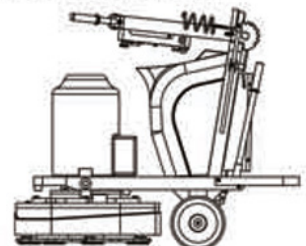

## 4.2 Transportation

For two person lifting, install the carrying poles into the front openings by screwing in the tapered ends.

When transporting the machine with hoisting equipment like a crane or a lift, check the total weight permitted (see Chapter 1 – dimensions or serial plate on machine). Use only appropriate and qualified hoisting equipment as well as ropes and chains. Do not fix any rope or chain to the handle. The machine must be placed on a pallet or platform designed to hold the weight of the machine and the platform or pallet can then be lifted or hoisted from the appropriate lifting points.



## 4.3 Transportation by Vehicle

When transporting the machine with vehicle, proceed in such a manner that damage due to the effects of use of force or incorrect loading and unloading is avoided. Use at least two straps, or tighten the machine with one strap to the cabin wall of the vehicle. Make sure that all parts of the machine are securely fixed before moving vehicle.

## 4.4 Procedure for Disassembly of Prep/Master® Jr.

### **Tools required:**

- M5 Allen wrench
- M18 wrench
- M10 Allen wrench

### **Procedure:**

1. With pocket weights in the baskets, remove the zip tie that is holding the motor cable to the handle assembly.
2. Remove the bolt holding the cable clamp to the handle assembly using the M5 Allen wrench.
3. Unplug the motor cable from the electrical cabinet.
4. Unhook the water line from the head of the grinder.
5. Loosen nuts holding the handle to the head using the M18 wrench.
6. Remove the bolts that hold the handle to the head using the M10 Allen wrench. (To avoid handle falling to the ground, be sure weights are in baskets, or have someone hold the handle.)

**Handle Section = 130 lbs. (without pocket weights)**

**Head Section = 260 lbs.**

## 4.5 Operation Conditions

Check the surface to be treated for loose parts (stones, screws, etc.). The surface must be swept if necessary. Make sure that the machine can travel over all inequalities on the surface. Small inequalities like floor joints less than ¼ inch are no barrier for the machine. The machine must be operated in accordance with instructions given in Chapter 5—Initial Operation.

## 5.0 Start Up

### 5.1 Preparing for Initial Operation

#### 5.2 Initial Operation

### 5.1 Preparing for Initial Operation



*All persons in the proximity of the machine must wear safety glasses with lateral protection as well as safety shoes. The operator is obliged to wear close-fitting protective clothing.*

- Before start up, ensure all existing protective housings are fitted and the filter unit is connected correctly.
- Check the surface to be treated. It should be free of loose parts (stones, screws, etc.). Sweep if necessary. Ensure that the machine can run over all inequalities on the surface (small inequalities like floor joints are not a barrier for the machine).



*In order to avoid downtimes a regular inspection is essential. Carry out the following checks before any start-up:*

- Check whether all machine parts are assembled safely and correctly.
- Check all screws and other fasteners for tight seat.
- Check the tool holders to ensure that the proper tools are in place and secure.
- Check the tightness of the hose connections and the condition of the hose to the filter.
- Make sure the dust container of the filter unit is empty. Please comply with the local waste treatment regulations considering the removed material.
- Check the electrical connections for dirt and foreign body deposits.
- Check the motor for dirt and other contaminants.



*Before start-up operators and other personnel must be familiar with the safety regulations given in this manual.*

1. Place the grinder in the area where work is to begin. Area must be level and free from debris.
2. Place weight(s) in pockets if needed.
3. Place handle in operation mode position.
4. Check the main power cable and the dust hose for damage. Replace or repair all damaged parts before starting the machine.
5. Connect the grinder and the filter unit with the dust hose. Use hose clamps at the connections.

Operation mode

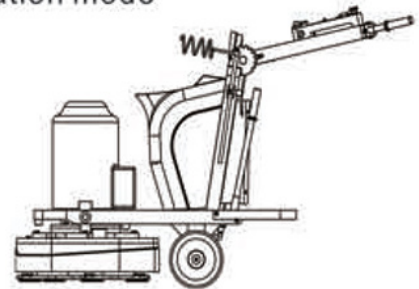

## 5.2 Initial Operation



*All persons near the machine must wear safety glasses with lateral protection, ear protection as well as safety shoes. The operator is obliged to wear close fitted protective clothing.*

Before start-up the operating personnel must be familiar with the safety regulations given in this manual.

***The start of the grinder and the filter unit is affected by the following sequence:***



*Attention! Before you plug the equipment to a power supply make sure the power supply is equivalent to the data shown on the machine label or the drive unit may obtain irreversible damage.*



*If there is no available power source within 50 m, please ask a professional electrician to install an available outlet close to the scope of work before work begins.*

1. Assure the electrical plug is connected correctly to the correct power source.
2. Assure the dust hose is connected correctly to the dust filter and grinding machine.
3. Switch the dust filter unit on.
4. Just in case the machine was stopped by the emergency switch, hold the P/M Jr.'s handle grip tightly and turn the emergency switch clockwise to release the stop feature.
5. Next, turn the ON Switch to the right to start the machine.



*If machine display screen shows "OL2," stop the machine immediately and consult with an experienced operator or an STI personnel to remedy the problem.*

6. Immediately begin moving the machine from side to side to prevent the tools from digging into the concrete surface and creating an uneven profile. For successful operation of the running machine, it is necessary to move the machine from side-to-side to create an even profile that is consistent in flatness and profile.
7. When grinding in work area is complete, turn the ON Switch to the left to stop the motor.
8. Empty the dust bin of the filter unit regularly.



*Do not overfill the bin to avoid dust exposure when opening the bin. Comply with the local waste treatment regulations when considering the removed material.*

---

## 6.0 Operation

---

- 6.1 Daily Operation
- 6.2 Replacing Diamonds
- 6.3 Failure
- 6.4 Safety Switch Off
- 6.5 Restart

---

### 6.1 Daily Operation

---

Normal start-up and operation of the grinder is similar to what has been described in Chapter 5—Initial operation.

Assure that grinding operation travels in parallel tracks so that the dust hose and electric cable do not become twisted.

Place machine handle in the middle position for operation mode.

The speed of moving the grinding machine over the work surface will influence the final finish and production. In the case that the surface shows different characteristics, meaning different hardness or different coating thicknesses, a uniform grinding result will be achieved by varying the speed of movement over the surface.

---

### 6.2 Replacing Diamonds

---

1. Adjust the handle bar to a middle position.
2. Holding the handle bar firmly, step on the pedal bracket located at the base of the machine.
3. Using your weight, push the handle bar to the floor. This will lift the machine head from the floor using counter-balance.
4. Install suitable diamonds.
5. Lift up handle slowly using the pedal bracket to operate counter-balance to place machine head back onto floor.
6. Adjust the handle bar to a suitable position for grinding operation.

Change abrasive state

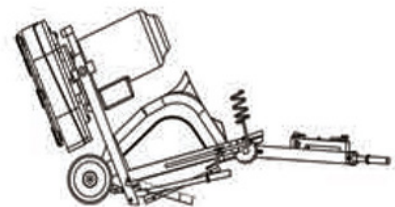

---

### 6.3 Failure

---

Regardless of the following information, the local safety regulations are valid in any case for the operation of the machine.

Assure all turning machine parts have come to a standstill before inspection or maintenance work begins. Always place in the Safety Off as described in Chapter 2.

---

### 6.4 Safety Switch Off

---



*The machine must be set into its “Safety Off Position” before starting any kind of maintenance or repair work.*

---

See Chapter 2—Safety Instructions.

### **Emergency Stop**

Push the red dial down quickly to stop the machine in an emergency.

To release, hold the PM Jr.'s handle grip tightly and turn the emergency switch clockwise to release the stop feature.

---

### 6.5 Restart

---



*All persons in the proximity of the machine must wear safety glasses with lateral protection as well as safety shoes. Ear protection may be required. The operator is obliged to wear close fitting protective clothing.*

---

See Chapter 5—Initial Operation.



## 7.0 Maintenance

- 7.1 Recommendations
- 7.2 Maintenance and Inspection
- 7.3 Maintenance
- 7.4 Regular Wear Parts

### 7.1 Recommendations



*Prior to any repair work on the machine, secure the machine against unintentional switch-on. Put the machine to its Safety Off Position as described in chapter 2.*

Failures due to inadequate or incorrect maintenance may generate very high repair costs and long stoppage periods of the machine. Regular maintenance is essential. Safety and service life of the machine depend, among other things, on proper maintenance.

The following table will show recommendations about time, inspection, and maintenance for the normal use of the machine. The time indications are based on uninterrupted operation. When the indicated number of working hours is not achieved during the corresponding period, the period can be extended.

However, due to different working conditions it cannot be foreseen how frequently inspections for wear checks, inspection, maintenance, and repair works ought to be carried out. Prepare a suitable inspection schedule considering your own working conditions. If any uncertainty, our specialists would be glad to give you any advice.

### 7.2 Maintenance and Inspection

Operating Hours / Time Period	Inspection Points / Maintenance Instructions
Daily — Prior to Operation	<ul style="list-style-type: none"> <li>• Check all cables/wires for cuts or damage</li> <li>• Check the hose connections for tightness and fixed seat.</li> <li>• Check the hose to the filter for damages.</li> <li>• Make sure that the dust bin of the filter has been dumped.</li> <li>• Check coupler, tool plate, and diamond tooling for wear and damage.</li> <li>• Check that shroud and rubber seal are in good working condition.</li> <li>• Check the electric connections for sediments of dirt or foreign bodies.</li> <li>• Check the electric motor/propane tank for dirt and other contaminants.</li> <li>• Check gearbox assembly for any leaks of oil from motor and top and bottom of gear box.</li> </ul>
Daily — After Operation	<ul style="list-style-type: none"> <li>• Check for debris, if any, in the dust ports under gear box as well as at handle.</li> <li>• Check for dirt build up on variable speed drive and electric motor.</li> </ul>



## 7.3 Maintenance

Only regular maintenance repairs are described within this manual.

You should always stock all spare or wear parts that cannot be supplied quickly in order to fulfill continued operation in case of any faults. As a general rule, production standstill periods are more expensive than the cost for the corresponding spare part.

Screws that have been removed must be replaced with those of the same quality (strength, material) and design.



*Prior to any repair work on the machine and its drives, secure the machine against unintentional switching-on. Pull out the main plug in order to do this.*

### Changing Gear Oil:

1. Disconnect machine from power source.
2. Secure machine in a stationary position.
3. With machine head on floor, remove the oil filler screw on top of gearbox with a hexagon screwdriver (*picture 2*).
4. Tip machine back to gain access to the oil port on bottom of gearbox (*picture 3*).
5. Remove the screws of the oil port.
6. Drain oil into approved container.
7. After oil has completely drained, replace the oil port screw on the bottom and lock tightly.
8. Return machine to an upright position.
9. Add 150# gear oil (1-1/4" depth).
10. After refilling is complete, replace the oil filler screw and seat tightly.



picture 1



picture 2



picture 3



picture 4



picture 5



picture 6

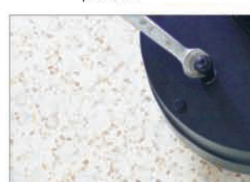

picture 7

## 7.4 Regular Wear Parts

Regular wear parts consist of the coupler, start switch, speed controller, rubber pads, and rubber dust skirt.

### To replace a worn or damaged Coupler, perform the following:

1. Remove the three socket head cap screws from drive plate using Allen key.
2. Then remove hex head bolts from tool plate.
3. Replace coupler.
4. Reassemble with head bolts securely tightened. Upon fixing assembly to machine, be sure that socket head cap screws are equally seated.\*



*\* When replacing bolts, be sure to hand start bolts BEFORE using any impact wrench to tighten down. This minimizes the risk of stripping threads by tightening an unseated bolt.*

## 8.0 Troubleshooting / Diagnostics

### 8.1 Diagnosis of Failures

#### 8.2 Diagnosis of Electrical Failure

#### 8.3 Diagnosis of Fault Codes

### 8.1 Diagnosis of Failures



*Prior to any repair work on the machine or drives, the machine must be secured against unintentional start-up. Put the machine in its Safety-off position.*

Failure	Possible Reasons for the Failure	Corrective Actions
Machine will not run	Input wire damage	Check input wiring for damage
	Wrong input voltage	Check voltage, or phase failure
	Wrong or loose wire connection between motor & inverter	Check for loose wire & reconnect
	Inverter problem	Repair or replace it
	Motor problem	Repair or replace it
Unusual Vibrations/ Machine shakes	Uneven or loose surface being ground	Verify suitability of substrate being ground.
	Abrasives are uneven thicknesses	Change diamonds to same grit size/ same height
	Loose or damaged tooling	Inspect tooling to make sure that all connecting hardware is tight and tool is firmly seated to holder.
Unusual Noise	Uneven or loose surface being ground	Verify suitability of substrate being ground.
	Loose or damaged tooling	Inspect tooling to make sure that all connecting hardware is tight and tool is firmly seated to holder.
	Shroud is dragging on the floor	Adjust shroud and tighten to no more than ¼ inch above floor
Reduced performance or no performance	Diamond tooling is worn or damaged	Inspect diamond tooling for remaining abrasive. If depleted, replace with new tooling.
Excessive dust being produced	Shroud is out of adjustment	Adjust shroud and tighten to no more than 2 mm above floor.
	Dust hose is clogged	Inspect dust hose and ports for debris that may be clogging hose.
	Dust collector malfunction	Verify dust collector is operating properly

Failure	Possible Reasons for the Failure	Corrective Actions
Abnormal noise	Plates collision	Replace new grinding plates and then tighten the locking screws
	Bearing or transmission shaft broken	Replace them
Oil leakage at plate rotation axis	Bearing damage inside gearbox	Replace it
	Oil sealer is aging or damage inside gear box	Replace them
Different abrasive weariness	Rubber aging or cracking	Replace it
	Grinding plates not on the same plain	Tighten the screws to make plates on the same level
	Buffering spring damage	Replace it
	Wheel axle and floor surface not on the same horizontal level	Adjust the wheel axle

## 8.2 Diagnosis of Electrical Failure



*Prior to any repair work on the machine or drives, the machine must be secured against unintentional start-up. Put the machine in its Safety-off position.*



*Work on electrical equipment or operating materials may only be undertaken by a skilled electrician or by trained persons under the guidance and supervision of a skilled electrician in accordance with the electrical engineering regulations.*

Failure	Possible Reasons for the Failure	Corrective Actions
Motor does not start up	Missing Phase/ Battery Failure	Check power supply or battery power
	Faulty Switch or relays	Get diagnosis and replacement by a skilled electrician
Motor stops during operation	Current power is too high / Low or no fuel	Disconnect plug / check fuel supply
	Supply circuit breaker is disengaged.	Reset circuit breaker or replace fuse.
	Motor is damaged.	Inspect motor.



*Call your local dealer if you can't solve the problem.*

### 8.3 Diagnosis of Fault Codes

#### The Fault Code of X Series Inverter As Follow.

Fault code		Possible fault reason	Troubleshooting
E.LU2	Voltage lack during operation	The supply voltage is too low; The capacity of power system is not big enough; or there is a big impulse current in the power system. The inner dc main contactor of the AC drive is not well connected.	Check power source input; Improve power supply system; Seek help from the factory.
E.oL1	Motor overload	The improper of V/F curve or the torque speed is too high; The network voltage is too low; The improper number setted of Overload on motor; The motor is in low speed for a long time.	Reset V/F curve or the torque speed. Check power source input; Reset parameter of [F5.06/18]; Choose the right capacity motor; Adopt the special purpose motor if require long-term low speed operation.
E.oL2	AC drive overload	Overload on AC drive; Acceleration time is too short; Activate the rotating motor; The improper of V/F curve or the torque speed is too high.	Choose the right capacity AC drive; Extend the acceleration time appropriately. Restart the motor while it totally stop or set [F1.00] in 1 or 2. Reset V/F curve or the torque speed.
E.S.C	System Exception	Acceleration time is too short; The AC drive output is interphase or short-circuit. The module is broken. The electromagnetic interference.	Increase the acceleration time; Check out the peripheral equipment and reset it after debugging. Seek help from the factory. Check out the wiring, grounding, shielding of the system and set it as requested.
E.oH2	The AC drive temperature sensor detects excessive heat.	The temperature is too high; The ventilation holes are obstructed. The plug-in of the fan is loose. The fan is damaged. The electric circuit breaks down.	Ensure that the ambient temperature falls within the specified temperature range. Make sure that the ventilation holes are not obstructed. Check and reconnect the fan. Replace the same model fan. Seek help from the factory.
E.iLF	Phase Loss	AC drive input phase loss	Check power source input
E.oLF	Phase Loss	AC drive input phase loss	Check power source output
E.EF	External fault	External devices protection	Check the external devices

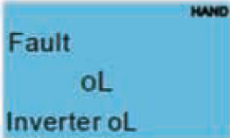
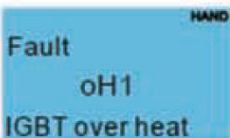
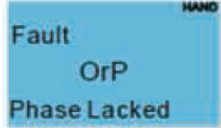

The Fault Code of Inverter of C2000(Q Series 380V)

Fault code	Display symbols	Possible fault reason	Troubleshooting
LVA		Inverter's Inner current at high Voltage is too low	<ol style="list-style-type: none"> <li>1. Check whether the input power is accordance with plug label on machine</li> <li>2. Check whether the input Voltage has the the default phase or not</li> <li>3. Check whether the motor has suddenly overload or not.</li> </ol>
OL		Output current of Inverter	<ol style="list-style-type: none"> <li>1. Check whether the input voltage has reached the machine normal working value.</li> <li>2. Check whether there are additional weight or not, if does, please remove it.</li> <li>3. Check whether the motor is overload.</li> </ol>
Oh1		Inverter inner overheat	<ol style="list-style-type: none"> <li>1. Check whether the input Voltage has reached the machine normal working value.</li> <li>2. Check whether there are the additional weight or not, if does, please remove it.</li> <li>3. Check whether the motor is overload.</li> </ol>
OrP		Default phase on input power	<ol style="list-style-type: none"> <li>1. Check whether there is default phase on input power.</li> <li>2. Check whether wire connecting between inverter and power line has loosen or not.</li> </ol>

**If the above fault code appeared, all the wire checking should be operated by professional people and only can check and maintain after cut off the power line and machine. Anything happened, do not deal with by yourself. Please contact the dealer whom you purchased in time.**

## The Fault Code of Inverter of VFD-B(Q Series 220V)

Fault code	Display symbols	Possible fault reason	Troubleshooting
LV	LV	Inverter's Inner current at high Voltage is too low	<ol style="list-style-type: none"> <li>1. Check whether the input power is accordance with plug label on machine</li> <li>2. Check whether the input Voltage has the the default phase or not</li> <li>3. Check whether the motor has suddenly overload or not.</li> </ol>
OL	OL	Output current of Inverter	<ol style="list-style-type: none"> <li>1. Check whether the input voltage has reached the machine normal working value.</li> <li>2. Check whether there are additional weight or not, if does, please remove it.</li> <li>3. Check whether the motor is overload.</li> </ol>
OL1	OL1	Inverter inner overheat	<ol style="list-style-type: none"> <li>1. Check whether the input Voltage has reached the machine normal working value.</li> <li>2. Check whether there are the additional weight or not, if does, please remove it.</li> <li>3. Check whether the motor is overload.</li> </ol>
OL2	OL2	Motor overload	<ol style="list-style-type: none"> <li>1. Check whether the wire connecting between motor and inverter is loosen or not.</li> <li>2. Check whether the input Voltage has reached the machine normal working value</li> <li>3. Check whether there are the additional weight or not, if does, please remove it.</li> <li>4. Check whether the motor is overload or not.</li> </ol>
PHL	PHL	Default phase on input power	<ol style="list-style-type: none"> <li>1. Check whether there is default phase on input power.</li> <li>2. Check whether wire connecting between inverter and power line has loosen or not.</li> </ol>

If the above fault code appeared, all the wire checking should be operated by professional people and only can check and maintain after cut off the power line and machine. Anything happened, do not deal with by yourself. Please contact the dealer whom you purchased in time.

## 9.0 Electric System Schematics

### Electrical Schematics of Motor and Invertor

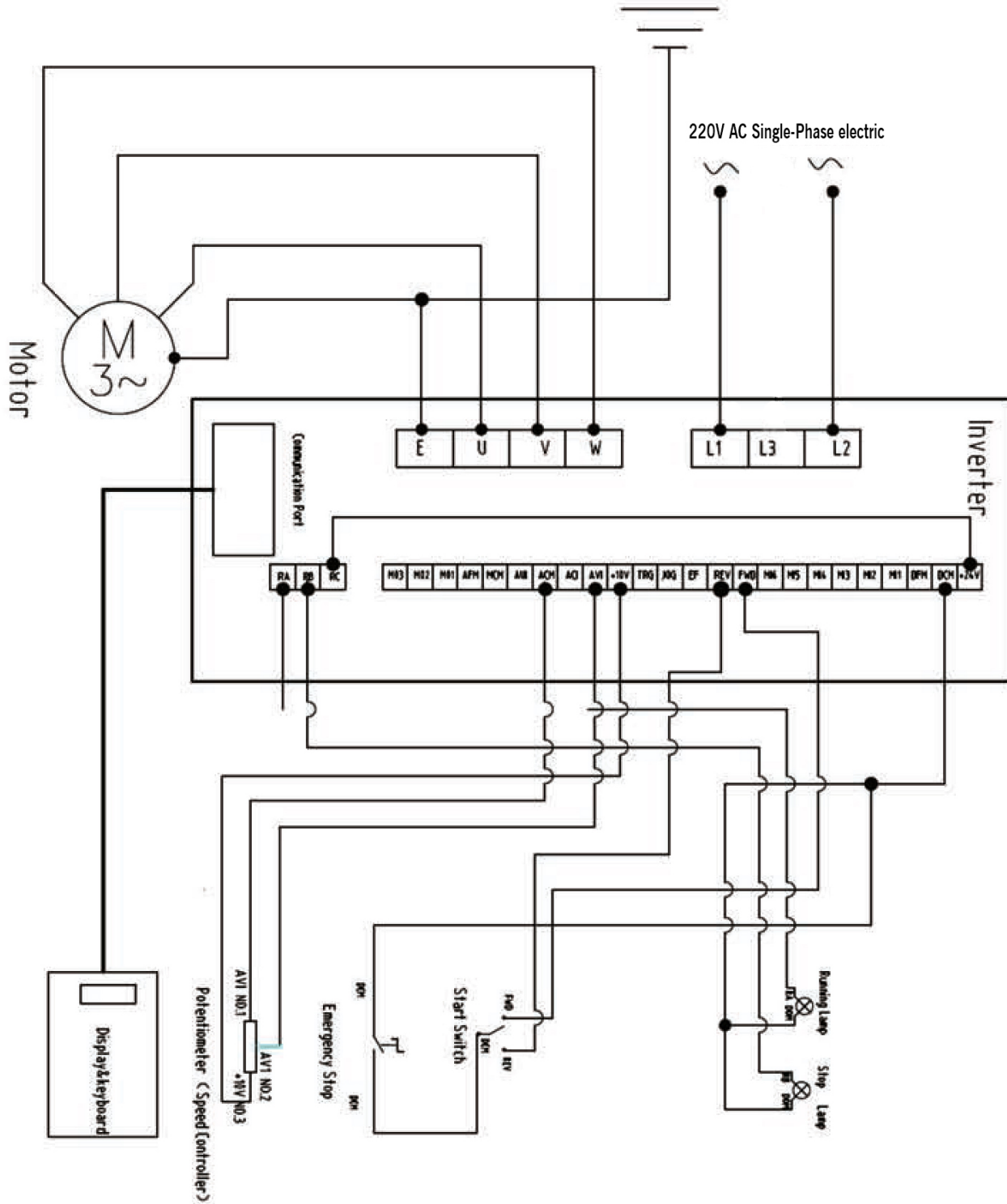

(Delta B)



*Circuit Schematics of LED and USB*

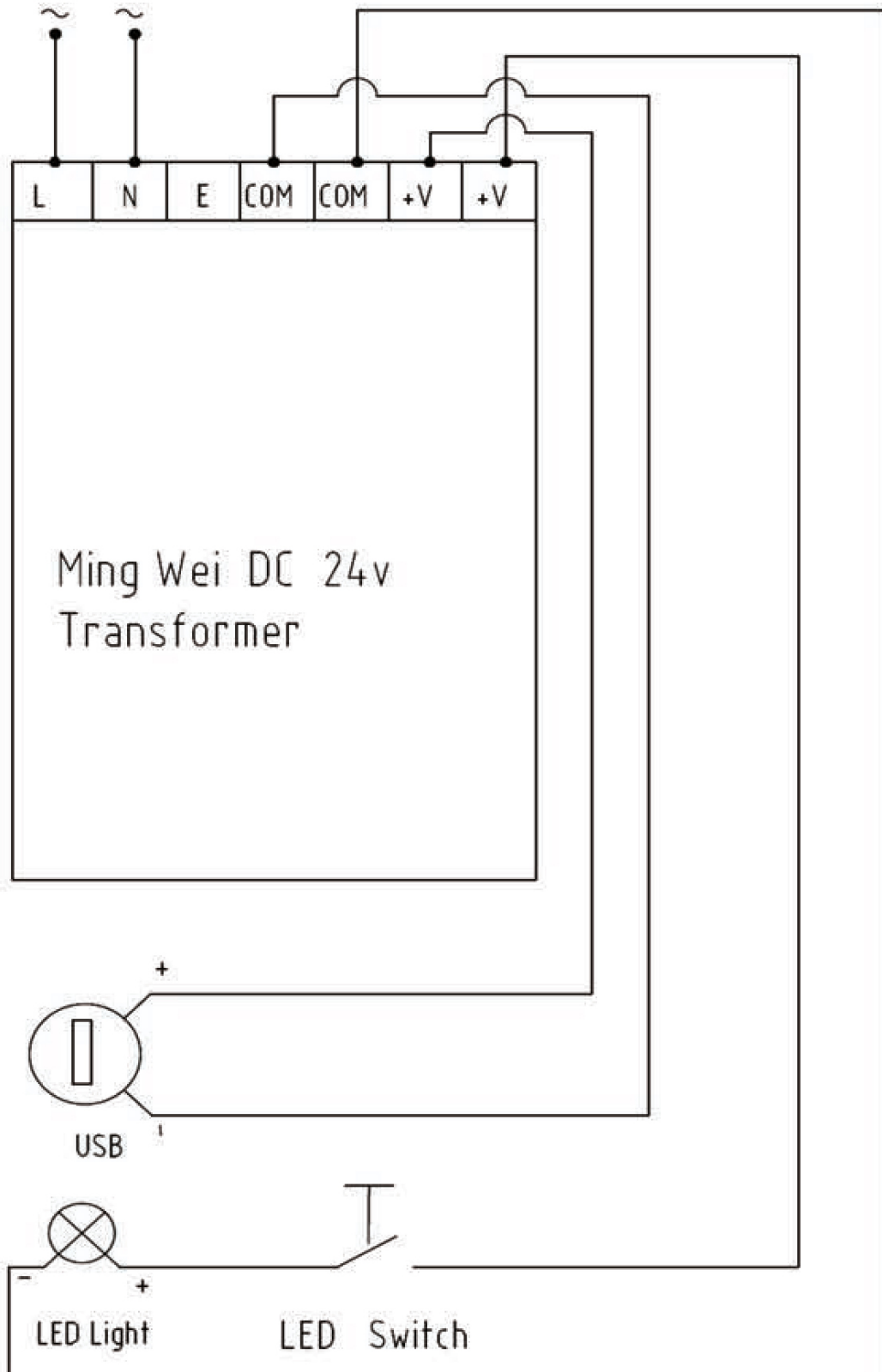

## 10.0 STI Reference Guide & Procedures

### 9.1 Polished Concrete - EGT Polishing System (Dry Steps)

### 9.2 Polished Concrete - CLC Polishing System (Dry-Wet-Dry Steps)

### 9.3 Terrazzo Polishing - TPS Polishing System (Dry-Wet Steps)

## 10.1 Polished Concrete - EGT Polishing System (Dry Steps)

The EGT Diamond System is a coordinated metal and resin bonded diamond system to produce a polished concrete floor using any of the eight models of P/M machines. The system is only to be used dry and in sequence as numbered by tools #1 through #8. All tools are painted green or use green velcro backings to indicate a matched system.

### EGT #1 & #2



These are metal bond tools that have the same face design and can be clearly identified by the number on back as “#1” and “#2.” Both tools feature the patented EG attachment system. Approximate life of #1 is 30,000 SF / 2,787 M<sup>2</sup> for all P/M Machines except 4430 (P/M Machine 4430 life expectancy is 40,000 SF / 3,716 M<sup>2</sup>) Approximate life of #2 is 35,000 SF / 3,251 M<sup>2</sup> for all P/M Machines except 4430 (P/M Machine 4430 life expectancy is 47,000 SF / 4,366 M<sup>2</sup>)



### EGT #3



This is a metal bond tool that has the pictured face design and can be clearly identified by the number on back as “#3.” This tool features the patented EG attachment system. Approximate life of #3 is 35,000 SF / 3,251 M<sup>2</sup> for all P/M Machines except 4430 (P/M Machine 4430 life expectancy is 47,000 SF / 4,366 M<sup>2</sup>)

### EGT #4



This is a 3” resin bonded tool that has the pictured face design and can be clearly identified by the number on back as “#4.” This tool features green Velcro backing. Approximate life of #4 is 20,000 SF / 1,858 M<sup>2</sup> for all P/M Machines except 4430 (P/M Machine 4430 life expectancy is 26,500 SF / 2,650 M<sup>2</sup>)

### EGT #5, #6, #7, & #8



#5, #6, #7 & #8 are 3” resin bonded tools that have the pictured face design and can be clearly identified by the number on back as “#5,” “#6,” “#7,” “#8.” These tools feature green Velcro backing. Approximate life of #5, #6, and #8 is 12,000 SF / 1,115 M<sup>2</sup> for all P/M Machines except 4430 (P/M Machine 4430 life expectancy is 16,000 SF / 1,486 M<sup>2</sup>). Approximate life of #7 is 10,000 SF / 930 M<sup>2</sup> for all P/M Machines except 4430 (P/M Machine 4430 life expectancy is 13,300 SF / 1,235 M<sup>2</sup>)

### Execution of EGT Polishing System

1. Attach the EGT #1 tools to the P/M Machine and place it in operating position. Attach appropriate power\* and vacuum dust collection hose to the P/M machine. With 50% of weights on head of machine and 50% in basket over wheels, set speed to 35Hz on VSD and start machine (for propane, run at 2200 RPM). Upon satisfactory completion of step #1, remove machine from area and vacuum the surface.

2. Attach the EGT #2 tools to the P/M Machine and place it in operating position. Attach appropriate power\* and vacuum dust collection hose to the P/M machine. With 100% of weights on head of machine, set speed to 35Hz on VSD and start machine (for propane, run at 2200 RPM). Upon satisfactory completion of step #2, remove machine from area and vacuum the surface.
3. Attach the EGT #3 tools to the P/M Machine and place it in operating position. Attach appropriate power\* and vacuum dust collection hose to the P/M machine. With 100% of weights on head of machine, set speed to 35Hz on VSD and start machine (for propane, run at 2200 RPM). Upon satisfactory completion of step #3, remove machine from area and vacuum the surface.
4. Attach the EGT #4 tools to the P/M Machine and place it in operating position. Attach appropriate power\* and vacuum dust collection hose to the P/M machine. With 100% of weights on head of machine, set speed to 35Hz on VSD and start machine (for propane, run at 2200 RPM). Upon satisfactory completion of step #4, remove machine from area and vacuum the surface.
5. Attach the EGT #5 tools to the P/M Machine and place it in operating position. Attach appropriate power\* and vacuum dust collection hose to the P/M machine. With 100% of weights on head of machine, set speed to 45Hz on VSD and start machine (for propane, run at 2500 RPM). Upon satisfactory completion of step #5, remove machine from area and vacuum the surface.
6. Apply densifier per manufacturer's recommendations and allow surface to dry completely after densifier process has been completed. See Section 3 for further information about densifiers.
7. Attach the EGT #6 tools to the P/M Machine and place it in operating position. Attach appropriate power\* and vacuum dust collection hose to the P/M machine. With 100% of weights on head of machine, set speed to 50Hz on VSD and start machine (for propane, run at 2700 RPM). Upon satisfactory completion of step #6, remove machine from area and vacuum the surface.
8. Attach the EGT #7 tools to the P/M Machine and place it in operating position. Attach appropriate power\* and vacuum dust collection hose to the P/M machine. With 100% of weights on head of machine, set speed to 50Hz on VSD and start machine (for propane, run at 2700 RPM) Upon satisfactory completion of step #7, remove machine from area and vacuum the surface.
9. Attach the EGT #8 tools to the P/M Machine and place it in operating position. Attach appropriate power\* and vacuum dust collection hose to the P/M machine. With 100% of weights on head of machine, set speed to 50Hz on VSD and start machine (for propane, run at 2700 RPM). Upon satisfactory completion of step #8, remove machine from area and vacuum the surface.

### **Qualifications**

As a general rule for all operations using the Prep/Master® machines:

- The machine manual MUST be read and understood by any operator for the safe and productive use of the machine.
- Upon starting the machine, continuously move the machine in a side-to-side pattern ensuring that the machine will grind the floor evenly. If for any reason the machine cannot be continuously moved, i.e. cord management, adjacent work, obstacles, etc., stop the machine until it can be operated as specified.
- A thorough processing of the concrete can only be achieved by one pass forward and then a second pass backward over same path. It is compulsory to overlap paths by at least 25%. The machine must always be swung side-to-side approximately 30 degrees. The machine should never be quickly pushed across floor to move to areas outside the area that is to be polished.
- The work area must be closed to all non-associated workers and equipment. The likelihood of contamination by non-associated traffic is increased and rogue scratches will be possible as well as overall reduced polish.

### **Flooring Condition Qualifications**

- Use of the EGT Diamond System requires that the surface to be treated is completely dry. For floors that have adhesives, built-up contaminants or other coatings, the surface must be first prepared using the #0 Prep Tool.
- Use of the EGT tools System can only be used, as specified above, for floors that are at least 4,250Psi/29Mpa and are over 28 days old.
- As a general rule, it is best to inspect floor BEFORE beginning to note or mark obstacles such as floor drains, protrusions from floor and elevation changes in excess of 2mm.
- Any polishing project that is undertaken should ALWAYS be preceded by a mock-up of at least 100 SF / 9 M<sup>2</sup>. This mock-up will serve two purposes: to provide a finished sample that owner can approve and to verify the suitability of the EGT Diamond System for the given slab.

### **Machinery Qualifications**

The EGT Diamond System is designed to attach to and work perfectly with any Substrate Technology Prep/Master® machine. Quantity of EGT tools will vary by model:

- Prep/Master® Jr.: 6 pieces
- Prep/Master® 2807/2818LP: 6 pieces
- Prep/Master® 2420/2418LP: 12 pieces
- Prep/Master® 3030/3038LP: 12 pieces
- Prep/Master® 4430/4438LP: 24 pieces

Attachment of EGT tools #4 through #8 require Velcro pad adapters #570000031 & #570000026.

### **Densifier Qualifications**

Manufacturer's instructions for use must be followed exactly for best results and to avoid any costly mistakes. Densifier must be the type that after its application, the floor is specified to be finished with a dry system and no water whatsoever.

## **10.2 Polished Concrete - CLC Polishing System (Dry-Wet-Dry Steps)**

The CLC Diamond System is a coordinated metal and resin bonded diamond system to perform polished concrete using any of the eight models of P/M machines.

The CLC Diamond System is only to be used dry for step #1, wet for steps #2, #3 & #4 and dry for steps #5, #6 & #7 and in sequence as numbered by tools #1 through #7. All tools are painted red or use red Velcro to indicate a matched system.

### **CLC #1**



CLC #1 is a metal bond tool painted red that has pictured face design and can be clearly identified by the number on back as "#1." This tool features the patented EG attachment system. The tool is run dry. Approximate life of #1 is 30,000 SF / 2,787 M<sup>2</sup>.

### **CLC #2**



#2 is a metal bond tool painted red that has pictured face design and can be clearly identified by the number on back as "#2." This tool features the patented EG attachment system. The tool is run wet. Approximate life of #2 is 30,000 SF / 2,787 M<sup>2</sup>.

### **CLC #3**



#3 is a 3" resin bonded tool that has the pictured face design and can be clearly identified by the number on back as "#3." This tool features red Velcro backing. The tool is run wet. Approximate life of #3 is 15,000 SF / 1,394 M<sup>2</sup>.

**CLC #4**

#4 is a 3" resin bonded tool that has the pictured face design and can be clearly identified by the number on back as "#4." This tool features red Velcro backing. The tool is run wet. Approximate life of #4 is 15,000 SF / 1,394 M<sup>2</sup>.

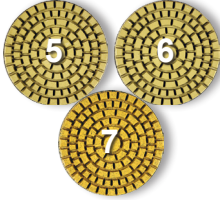
**CLC #5, #6, & #7**

#5, #6 & #7 are 3" resin bonded tools that each have the pictured face design and can be clearly identified by the number on back as "#5", "#6" & "#7." These tools feature red Velcro backing. The tool is run dry. Approximate life of #5 & #7 is 12,000 SF / 1,115 M<sup>2</sup> each. Approximate life of #6 is 10,000 SF / 930 M<sup>2</sup> each.

**Execution of CLC Polishing System**

1. Attach the CLC #1 tools to the P/M machine and place it in operating position. Attach appropriate power\* and vacuum dust collection hose to the P/M machine. With 50% of weights on head of machine and 50% in basket over wheels, set speed to 35Hz on VSD and start machine (for propane, run at 2200 RPM). Upon satisfactory completion of step #1, remove machine from area and vacuum the surface.
2. Attach the CLC #2 tools to the P/M machine and place it in operating position. Attach appropriate power\* to the P/M machine. With 50% of weights on head of machine and 50% in basket over wheels, set speed to 45Hz on VSD and start machine (for propane, run at 2500 RPM), add water and start the machine. Upon satisfactory completion of step #2, remove machine from area and wet vacuum or auto-scrub the concrete clean.
3. Apply densifier per manufacturer's recommendations and allow surface to dry completely after densifier process has been completed. See Section 3 for further information about densifiers.
4. Attach the CLC #3 tools to the P/M machine and place it in operating position. Attach appropriate power\* to the P/M machine. With 50% of weights on head of machine and 50% in basket over wheels, set speed to 45Hz on VSD, add water, and start machine (for propane, run at 2500 RPM). Upon satisfactory completion of step #3, remove machine from area and wet vacuum or auto-scrub the concrete clean.
5. Attach the CLC #4 tools to the P/M machine and place it in operating position. Attach appropriate power\* to the P/M machine. With 50% of weights on head of machine and 50% in basket over wheels, set speed to 45Hz on VSD and start machine (for propane, run at 2500 RPM), add water and start the machine. Upon satisfactory completion of step #4, remove machine from area and wet vacuum or auto-scrub the concrete clean.
6. Attach the CLC #5 tools to the P/M machine and place it in operating position. Attach appropriate power\* and vacuum dust collection hose to the P/M machine. With 100% of weights on head of machine, set speed to 50Hz on VSD and start machine (for propane, run at 2700 RPM). Upon satisfactory completion of step #5, remove machine from area and vacuum the surface.
7. Apply densifier per manufacturer's recommendations and allow surface to dry completely after densifier process has been completed. See Section 3 for further information about densifiers.
8. Attach the CLC #6 tools to the P/M machine and place it in operating position. Attach appropriate power\* and vacuum dust collection hose to the P/M machine. With 100% of weights on head of machine, set speed to 50Hz on VSD and start machine (for propane, run at 2700 RPM). Upon satisfactory completion of step #6, remove machine from area and vacuum the surface.
9. Attach the CLC #7 tools to the P/M machine and place it in operating position. Attach appropriate power\* and vacuum dust collection hose to the P/M machine. With 100% of weights on head of machine, set speed to 50Hz on VSD and start machine (for propane, run at 2700 RPM). Upon satisfactory completion of step #7, remove machine from area and vacuum the surface.



## **Qualifications**

As a general rule for all operations using the Prep/Master® machines:

- The machine manual **MUST** be read and understood by any operator for the safe and productive use of the machine.
- The use of the machine and water must only be done by skilled workers that have been trained and understand the safety precautions that need to be undertaken. The danger of electric shock is present anytime water is used with electrical machinery. Water also presents the possibility that any floor openings or drains can serve as a conduit for water to damage unintended areas. The disposal of wet waste or slurry must be done in accordance with all local laws and regulations.
- Upon starting the machine, continuously move machine in side-to-side pattern ensuring that machine is continuously moved while running. If for any reason the machine cannot be continuously moved, i.e. cord management, adjacent work, obstacles, etc., stop the machine until it can be operated as specified.
- A thorough processing of the concrete can only be achieved by one pass forward and then second pass backward over same path. It is compulsory to overlap paths by at least 25%. The machine must always be swung side-to-side approximately 30 degrees. The machine should never be quickly pushed across floor to move to areas outside the area that is to be polished.
- The work area must be closed to all non-associated workers and equipment. The likelihood of contamination by non-associated traffic is increased and rogue scratches will be possible as well as overall reduced polish.

## **Flooring Condition Qualifications**

Use of the CLC Diamond System requires that the surface to be treated is clean of coatings or adhesives. For floors that have adhesives, built-up contaminants or other coatings, the surface must be first prepared using the #0 Prep Tool.

Use of the CLC Diamond System can only be used, as specified above, for floors that are at least 4,250Psi/29Mpa and are over 28 days old.

As a general rule, it is best to inspect floor **BEFORE** beginning to note or mark obstacles such as floor drains, protrusions from floor and elevation changes in excess of 2mm.

Any polishing project that is undertaken should **ALWAYS** be preceded by a mock-up of at least 100 SF / 9 M<sup>2</sup>. This mock-up will serve two purposes: to provide a finished sample that owner can approve and to verify the suitability of the CLC Diamond System for the given slab.

## **Machinery Qualifications**

The CLC Diamond System is designed to attach to and work perfectly with any Substrate Technology Prep/Master® machine. Quantity of CLC tools will vary by model:

- Prep/Master® Jr.: 6 pieces
- Prep/Master® 2807/2818: 6 pieces
- Prep/Master® 2420/2418: 12 pieces
- Prep/Master® 3030/3038: 12 pieces
- Prep/Master® 4430/4438: 24 pieces

Attachment of CLC tools #3 through #7 require Velcro pad adapters 570000031 & 570000026.

## **Densifier Qualifications**

Manufacturer's instructions for use must be followed exactly for best results and to avoid any costly mistakes. Densifier must be type, that after its application, the floor is specified to be finished with a dry system and no water whatsoever.

## 10.3 Terrazzo Polishing - TPS Polishing System (Dry-Wet Steps)

The TPS System is a coordinated metal and resin bonded diamond system to perform grinding and polishing of new Epoxy Terrazzo using any of the eight models of P/M machines.

The TPS System is only to be used dry for steps #1, #2 & #3 and wet only for steps #4, #5, #6 & #7 and in sequence as numbered by tools #1 through #7. All tools are painted orange or use orange Velcro to indicate a matched system.

Since a portion of the TPS System is performed wet, its use should only be by those familiar with all safety and productive work practices while using water.

### TPS #1



#1 is a metal bond tool painted orange that has pictured face design and can be clearly identified by the number on back as “#1.” This tool features the patented EG attachment system. The tool is run dry. Approximate life of #1 is 12,000 SF / 1,115 M<sup>2</sup> for all P/M Machines except 4430. (P/M Machine 4430 life expectancy is 15,500 SF / 1,440 M<sup>2</sup>.)

This tool is the first cut tool for Epoxy Terrazzo rough cut step. The #1 TPS tool life will be variable based upon Epoxy Terrazzo mixture components, consistency of epoxy terrazzo placement, and adequate dust collection.

### TPS #2



#2 is a metal bond tool painted orange that has pictured face design and can be clearly identified by the number on back as “#2.” This tool features the patented EG attachment system. The tool is run dry. Approximate life of #2 is 30,000 SF / 2,787 M<sup>2</sup> for all P/M Machines except 4430. (P/M Machine 4430 life expectancy is 40,000 SF / 3,716 M<sup>2</sup>.)

### TPS #3



#3 is a metal bond tool painted orange that has pictured face design and can be clearly identified by the number on back as “#3.” This tool features the patented EG attachment system. The tool is run dry. Approximate life of #3 is 30,000 SF / 2,787 M<sup>2</sup> for all P/M Machines except 4430. (P/M Machine 4430 life expectancy is 40,000 SF / 3,716 M<sup>2</sup>.)

### TPS #3.5 (Grout Pan)



Grout Pan #3.5 is a patent pending stainless steel tool that has the pictured face design and can be clearly identified by the stamping on back Velcro as “#3.5” This tool features orange Velcro backing. The tool is run with epoxy and marble flour (calcium carbonate powder). Approximate life of #3.5 is 10,000 SF / 929 M<sup>2</sup>. (See execution for more details.)

### TPS #4



#4 is a resin bonded tool that has the pictured face design and can be clearly identified by the number on back as “#4.” This tool features orange Velcro backing. The tool is run wet. Approximate life of #4 is 15,000 SF / 1,394 M<sup>2</sup> for all P/M Machines except 4430. (P/M Machine 4430 life expectancy is 20,000 SF / 1,858 M<sup>2</sup>.)

### TPS #5, #6, & #7



#5, #6 & #7 are resin bonded tools that have the pictured face design and can be clearly identified by the numbers on back as “#5,” “#6,” & “#7.” These tools feature orange Velcro backing. The tools are run wet. Approximate life of #5, #6 & #7 are 15,000 SF / 1,440 M<sup>2</sup> for all P/M Machines except 4430. (P/M Machine 4430 life expectancy is 20,000 SF / 1,858 M<sup>2</sup> each.)



### Execution of TPS Polishing System

1. Attach the TPS #1 tools to the P/M Machine and place it in operating position. Attach appropriate power\* and vacuum dust collection hose to the P/M machine. With 100% of weights on head of machine, set speed to 40Hz on VSD and start machine (for propane, run at 2350 RPM). Upon satisfactory completion of step #1, remove machine from area and vacuum the surface.
2. Attach the TPS #2 tools to the P/M Machine and place it in operating position. Attach appropriate power\* to the P/M machine. With 100% of weights on head of machine, set speed to 40Hz on VSD and start machine (for propane, run at 2350 RPM). Upon satisfactory completion of step #2, remove machine and vacuum clean.
3. Attach the TPS #3 tools to the P/M Machine and place it in operating position. Attach appropriate power\* to the P/M machine. With 100% of weights on head of machine, set speed to 40Hz on VSD and start machine (for propane, run at 2350 RPM). Upon satisfactory completion of step #3, remove machine and vacuum clean.
4. Grout the floor with approved epoxy grouting material by either traditional method using marble flour (calcium carbonate powder) and a steel trowel, or with the STI Grout Pans (TPS #3.5) on P/M machine (or similar rotary machine) with marble flour. Let dry a minimum of eight hours. *Please note: the STI Grout Pans can only be run on the P/M machine at 15Hz or 2100 RPM with the pocket weights on the handle. Not running as recommended will greatly reduce pan life expectancy and may produce burn marks in the floor. Never use the pans on machines that have RPM in excess of 250RPM tool speed.*
5. Attach the TPS #4 tools to the P/M Machine and place it in operating position. Attach appropriate power\* to the P/M machine. With 50% of weights on head of machine and 50% in basket over wheels, set speed to 45Hz on VSD and start machine (for propane, run at 2500 RPM). Upon satisfactory completion of step #4, remove machine from area and wet vacuum or auto-scrub the concrete clean.
6. Attach the TPS #5 tools to the P/M Machine and place it in operating position. Attach appropriate power\* to the P/M machine. With 50% of weights on head of machine and 50% in basket over wheels, set speed to 45Hz on VSD and start machine (for propane, run at 2500 RPM). Upon satisfactory completion of step #5, remove machine from area and wet vacuum or auto-scrub the concrete clean.
7. Attach the TPS #6 tools to the P/M Machine and place it in operating position. Attach appropriate power\* to the P/M machine. With 50% of weights on head of machine and 50% in basket over wheels, set speed to 45Hz on VSD and start machine (for propane, run at 2500 RPM). Upon satisfactory completion of step #6, remove machine from area and wet vacuum or auto-scrub the concrete clean.
8. Attach the TPS #7 tools to the P/M Machine and place it in operating position. Attach appropriate power\* to the P/M machine. With 50% of weights on head of machine and 50% in basket over wheels, set speed to 45Hz on VSD and start machine (for propane, run at 2500 RPM). Upon satisfactory completion of step #7, remove machine from area and wet vacuum or auto-scrub the concrete clean.

### Qualifications

As a general rule for all operations using the Prep/Master® machines:

- The machine manual MUST be read and understood by any operator for the safe and productive use of the machine.
- The use of the machine and water must only be done by skilled workers that have been trained and understand the safety precautions that need to be undertaken. The danger of electric shock is present anytime water is used with electrical machinery. Water also presents the possibility that any floor openings or drains can serve as a conduit for water to damage unintended areas. The disposal of wet waste or slurry must be done in accordance with all local laws and regulations.

- Upon starting the machine, continuously move the machine in a side-to-side pattern ensuring that the machine will grind the floor evenly. If for any reason the machine cannot be continuously moved, i.e. cord management, adjacent work, obstacles, etc., stop the machine until it can be operated as specified.
- When cutting a new epoxy terrazzo floor, installation flatness will affect production greatly. The TPS #1 tool is specified as the “first cut” tool since it is the most aggressive in the system and designed to quickly remove floor stock. As such, any new floor must be ground to full aggregate exposure using the TPS #1 tools before commencing with subsequent steps. Being that subsequent steps are finer than #1, these tools cannot be expected to perform any more aggregate exposure; only to remove scratches from previous steps.
- A thorough processing of the epoxy terrazzo can only be achieved by one pass forward and then second pass backward over same path. It is compulsory to overlap paths by at least 25%. The machine must always be swung side-to-side approximately 30 degrees. The machine should never be quickly pushed across floor to move to areas outside the area that is to be polished.
- The work area must be closed to all non-associated workers and equipment. The likelihood of contamination by non-associated traffic is increased and rogue scratches will be possible as well as overall reduced polish.

### ***Flooring Condition Qualifications***

Use of the TPS Diamond System requires that the epoxy terrazzo floor is at least eight hours old. As a general rule, it is best to inspect floor BEFORE beginning to note or mark obstacles such as floor drains, protrusions from floor.

Any polishing project that is undertaken should ALWAYS be preceded by a mock-up of at least 100 SF / 9 M<sup>2</sup>. This mock-up will serve two purposes: to provide a finished sample that owner can approve.

### ***Machinery Qualifications***

The TPS Diamond System is designed to attach to and work perfectly with any Substrate Technology Prep/Master® machine. Quantity of TPS tools will vary by model:

- Prep/Master® Jr.: 6 pieces
- Prep/Master® 2807/2818: 6 pieces
- Prep/Master® 2420/2418: 12 pieces
- Prep/Master® 3030/3038: 12 pieces
- Prep/Master® 4430/4438: 24 pieces

Attachment of TPS tools #4 through #7 require Velcro pad adapters 570000031 & 570000026.





*Service • Support • Success*

Substrate Technology, Inc.  
1384 Bungalow Rd.  
Morris, IL 60450 USA  
(815) 941-4800  
(815) 941-4600 Fax  
[www.substratetechnology.com](http://www.substratetechnology.com)